

Pushbutton Switches

A22NN/A22NL

22-mm Pushbutton Switches

Universal Design.

Emphasis on Color Coding, Workability, and Safety.

Easy to Use

- You can connect up to three Contact Blocks in one stage for multistage expansion.
- The terminals can be retightened when Contact Blocks are stacked.
- Contact Blocks can be attached in any direction for easy assembly.
- Screw terminal structure is compatible with round crimp terminals.

Safety

- Easy-to-operate lock lever for secure locking.
- Easy-mounting Contact Blocks provide finger protection.
- Different colors of Contact Blocks (NO: blue, NC: orange) help prevent wiring errors.

Product Lineup

- Meet global safety standards.
- Available with metal or plastic bezels.
- Many color variations.
- Standard-feature degree of protection: IP66, NEMA 4X, and NEMA 13.



Refer to *Safety Precautions for All Pushbutton Switches/Indicators* and *Safety Precautions* on page 23.



Button Colors

		Non-lighted Switches							
		Red	Green	Yellow	White	Blue	Black		
Non-lighted Switches	A22NN-□□□-N□ Opaque								
	A22NN-□□□-U□ Transparent								
Lighted Switches	A22NL-□□□-T□ Transparent	When not lit	Red	Green	Yellow	White	Blue	Orange	White
		When lit	Red	Green	Yellow	White	Blue	Orange	Opaque white*

* The colors when the Switches are lit are for transparent white buttons (code: TW) and yellow LED Lamps (code: Y).

A22NN/A22NL

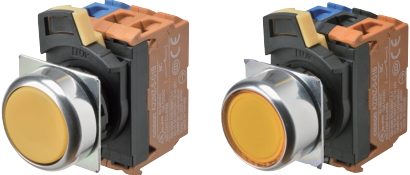
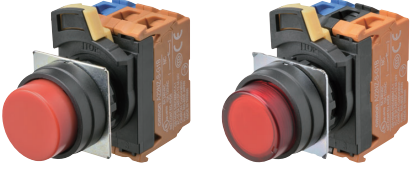
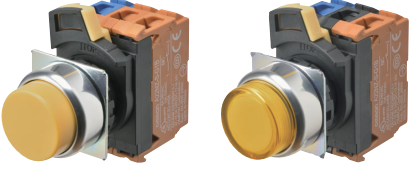
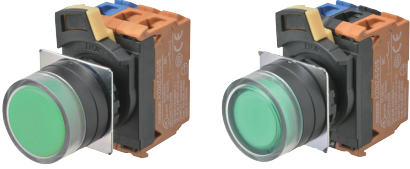
List of Models

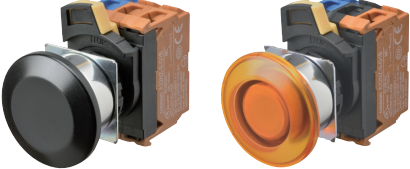
Plastic bezels	Brushed metal bezels	Metal bezels
A22N□-BN	A22N□-MN	A22N□-RN
Flat	Flat	Flat
		
A22N□-BP	A22N□-MP	A22N□-RP
Projected	Projected	Projected
		
A22N□-BG	A22N□-MG	
Full guard	Full guard	
		
A22N□-BM	A22N□-MM	A22N□-RM
Mushroom	Mushroom	Mushroom
		

Model Number Structure

Model Number Legend - - - - Shipped as a set that includes the Operation Unit, LED Lamp, Mounting Collar, and Contact Block.
For information on combinations, refer to *Ordering Information* on pages 4 to 7.

Model Numbers for Sets

A 2 2 N ⁽¹⁾ L - ⁽²⁾ BN ⁽³⁾ M - ⁽⁴⁾ TR ⁽⁵⁾ A - ⁽⁶⁾ G ⁽⁷⁾ 100 - ⁽⁸⁾ R ⁽⁹⁾ B

(1) Type

Code	Description
N	Non-lighted
L	Lighted

(2) Bezel Material and Button Shape

Code	Bezel material	Button shape
BN	Plastic	Flat
BP	Plastic	Projected
BG	Plastic	Full guard
BM	Plastic	Mushroom
MN	Brushed metal	Flat
MP	Brushed metal	Projected
MG	Brushed metal	Full guard
MM	Brushed metal	Mushroom
RN	Metal	Flat
RP	Metal	Projected
RM	Metal	Mushroom

(3) Switch Action

Code	Description
M	Momentary
A	Alternate

(4) Button Transparency and Color and (8) LED Lamp Color

Lighted/non-lighted	Code (4)	Code (8)	Transparency	Button color	LED lamp color
Non-lighted	NR	N	Opaque	Red	---
	NG	N	Opaque	Green	
	NY	N	Opaque	Yellow	
	NW	N	Opaque	White	
	NA	N	Opaque	Blue	
	NB	N	Opaque	Black	
	UR	N	Transparent	Red	
	UG	N	Transparent	Green	
	UY	N	Transparent	Yellow	
	UW	N	Transparent	White	
	UA	N	Transparent	Blue	
	UO	N	Transparent	Orange	
Lighted	TR	R	Transparent	Red	Red
	TG	G	Transparent	Green	Green
	TY	Y	Transparent	Yellow	Yellow
	TW	W	Transparent	White	White
	TA	A	Transparent	Blue	Blue
	TO	O	Transparent	Orange	Orange
	TW	Y	Transparent	White *	Yellow

* The color is opaque white when the Switch is lit.

(5) Degree of Protection

Code	Description
A	IP66, NEMA 4X, NEMA13

(6) Contact Specification

Code	Description
G	General purpose

(7) Contacts

Code	Contact Blocks		Unit position					
			Non-lighted			Lighted		
	NO	NC	(1)	(2)	(3)	(1)	(2)	(3)
100	1	0	NO	---	---	NO	Lighting Unit	---
002	0	1	---	---	NC	---	Lighting Unit	NC
101	2	0	NO	---	NO	NO	Lighting Unit	NO
102	1	1	NO	---	NC	NO	Lighting Unit	NC
202	0	2	NC	---	NC	NC	Lighting Unit	NC
111	3	0	NO	NO	NO			
112	2	1	NO	NO	NC			
122	1	2	NO	NC	NC			
222	0	3	NC	NC	NC			

Note: 1. NO (blue): Normally open, NC (orange): Normally closed.
2. Refer to the following figure for Unit positions.

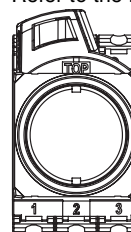

(9) LED Lamp Voltage

Code	LED Lamp voltage
N	Non-lighted
A	6 VAC/DC
B	12 VAC/DC
C	24 VAC/DC
D	100/110/120 VAC
E	200/220/230/240 VAC

■ Specifications: Refer to page 15.
■ Dimensions: Refer to page 17.



■ Precautions for correct use: Refer to page 23.
■ Accessories and tools: Refer to page 13.

A22NN/A22NL



Ordering Information

Model Numbers for Sets - - - - Shipped as a set that includes the Operation Unit, LED Lamp, Mounting Collar, and Contact Block.

Non-lighted, Flat Switches

Appearance	Contacts	Momentary action (self-resetting)	Alternate action (self-holding)	(2)(2) Button color	(7)(7)(7) Contacts
		Model	Model		
 Plastic bezels	1	A22NN-BNM-(2)(2)A-G(7)(7)(7)-NN	A22NN-BNA-(2)(2)A-G(7)(7)(7)-NN	NR: Opaque, red NG: Opaque, green NY: Opaque, yellow NW: Opaque, white NA: Opaque, blue NB: Opaque, black UR: Transparent, red UG: Transparent, green UY: Transparent, yellow UW: Transparent, white UA: Transparent, blue UO: Transparent, orange	100 002
	2	A22NN-BNM-(2)(2)A-G(7)(7)(7)-NN	A22NN-BNA-(2)(2)A-G(7)(7)(7)-NN		101 102 202
	3	A22NN-BNM-(2)(2)A-G(7)(7)(7)-NN	A22NN-BNA-(2)(2)A-G(7)(7)(7)-NN		111 112 122 222
 Brushed metal bezels	1	A22NN-MNM-(2)(2)A-G(7)(7)(7)-NN	A22NN-MNA-(2)(2)A-G(7)(7)(7)-NN		100 002
	2	A22NN-MNM-(2)(2)A-G(7)(7)(7)-NN	A22NN-MNA-(2)(2)A-G(7)(7)(7)-NN		101 102 202
	3	A22NN-MNM-(2)(2)A-G(7)(7)(7)-NN	A22NN-MNA-(2)(2)A-G(7)(7)(7)-NN		111 112 122 222
 Metal bezels	1	A22NN-RNM-(2)(2)A-G(7)(7)(7)-NN	A22NN-RNA-(2)(2)A-G(7)(7)(7)-NN		100 002
	2	A22NN-RNM-(2)(2)A-G(7)(7)(7)-NN	A22NN-RNA-(2)(2)A-G(7)(7)(7)-NN		101 102 202
	3	A22NN-RNM-(2)(2)A-G(7)(7)(7)-NN	A22NN-RNA-(2)(2)A-G(7)(7)(7)-NN		111 112 122 222

Lighted, Flat Switches

Appearance	Contacts	Momentary action (self-resetting)	Alternate action (self-holding)	(2)(2) Button color	(7)(7)(7) Contacts	(8) LED Lamp color	(9) LED Lamp voltage
		Model	Model				
 Plastic bezels	1	A22NL-BNM-(2)(2)A-G(7)(7)(7)-(8)(9)	A22NL-BNA-(2)(2)A-G(7)(7)(7)-(8)(9)	TR: Transparent, red TG: Transparent, green TY: Transparent, yellow TW: Transparent, white TA: Transparent, blue TO: Transparent, orange	100 002	R: Red G: Green Y: Yellow W: White A: Blue O: Orange	A: 6 VAC/DC B: 12 VAC/DC C: 24 VAC/DC D: 100/110/120 VAC E: 200/220/230/240 VAC
		2	A22NL-BNM-(2)(2)A-G(7)(7)(7)-(8)(9)				
	 Brushed metal bezels	1	A22NL-MNM-(2)(2)A-G(7)(7)(7)-(8)(9)		A22NL-MNA-(2)(2)A-G(7)(7)(7)-(8)(9)		
2			A22NL-MNM-(2)(2)A-G(7)(7)(7)-(8)(9)		A22NL-MNA-(2)(2)A-G(7)(7)(7)-(8)(9)		
 Metal bezels		1	A22NL-RNM-(2)(2)A-G(7)(7)(7)-(8)(9)		A22NL-RNA-(2)(2)A-G(7)(7)(7)-(8)(9)		
	2		A22NL-RNM-(2)(2)A-G(7)(7)(7)-(8)(9)		A22NL-RNA-(2)(2)A-G(7)(7)(7)-(8)(9)		

Note: Normally, the Button and LED Lamp with the same color are combined.
 However, opaque white is available by combining a white Button and yellow LED. A22N□-□□□-TWA-G□□□-Y□



■ Subassemblies: Refer to pages 8 to 12.
 (You can order Operation Units, LED Lamps, Mounting Collars, and Contact Blocks individually.)

■ Specifications: Refer to page 15. ■ Dimensions: Refer to page 17.
 ■ Accessories and tools: Refer to page 13.



Ordering Information

Model Numbers for Sets - - - Shipped as a set that includes the Operation Unit, LED Lamp, Mounting Collar, and Contact Block.

Non-lighted, Projected Switches

Appearance	Contacts	Momentary action (self-resetting)	Alternate action (self-holding)	(2)(2) Button color	(7)(7)(7) Contacts
		Model	Model		
	1	A22NN-BPM-(2)(2)A-G(7)(7)(7)-NN	A22NN-BPA-(2)(2)A-G(7)(7)(7)-NN	NR: Opaque, red NG: Opaque, green NY: Opaque, yellow NW: Opaque, white NA: Opaque, blue NB: Opaque, black UR: Transparent, red UG: Transparent, green UY: Transparent, yellow UW: Transparent, white UA: Transparent, blue UO: Transparent, orange	100 002
	2	A22NN-BPM-(2)(2)A-G(7)(7)(7)-NN	A22NN-BPA-(2)(2)A-G(7)(7)(7)-NN		101 102 202
	3	A22NN-BPM-(2)(2)A-G(7)(7)(7)-NN	A22NN-BPA-(2)(2)A-G(7)(7)(7)-NN		111 112 122 222
	1	A22NN-MPM-(2)(2)A-G(7)(7)(7)-NN	A22NN-MPA-(2)(2)A-G(7)(7)(7)-NN		100 002
	2	A22NN-MPM-(2)(2)A-G(7)(7)(7)-NN	A22NN-MPA-(2)(2)A-G(7)(7)(7)-NN		101 102 202
	3	A22NN-MPM-(2)(2)A-G(7)(7)(7)-NN	A22NN-MPA-(2)(2)A-G(7)(7)(7)-NN		111 112 122 222
	1	A22NN-RPM-(2)(2)A-G(7)(7)(7)-NN	A22NN-RPA-(2)(2)A-G(7)(7)(7)-NN		100 002
	2	A22NN-RPM-(2)(2)A-G(7)(7)(7)-NN	A22NN-RPA-(2)(2)A-G(7)(7)(7)-NN		101 102 202
	3	A22NN-RPM-(2)(2)A-G(7)(7)(7)-NN	A22NN-RPA-(2)(2)A-G(7)(7)(7)-NN		111 112 122 222

Lighted, Projected Switches

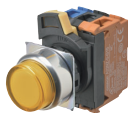
Appearance	Contacts	Momentary action (self-resetting)	Alternate action (self-holding)	(2)(2) Button color	(7)(7)(7) Contacts	(8) LED Lamp color	(9) LED Lamp voltage			
		Model	Model							
	1	A22NL-BPM-(2)(2)A-G(7)(7)(7)-(8)(9)	A22NL-BPA-(2)(2)A-G(7)(7)(7)-(8)(9)	TR: Transparent, red TG: Transparent, green TY: Transparent, yellow TW: Transparent, white TA: Transparent, blue TO: Transparent, orange	100 002	R: Red G: Green Y: Yellow W: White A: Blue O: Orange	A: 6 VAC/DC B: 12 VAC/DC C: 24 VAC/DC D: 100/110/120 VAC E: 200/220/230/240 VAC			
		A22NL-BPM-(2)(2)A-G(7)(7)(7)-(8)(9)	A22NL-BPA-(2)(2)A-G(7)(7)(7)-(8)(9)					101 102 202		
	2	A22NL-BPM-(2)(2)A-G(7)(7)(7)-(8)(9)	A22NL-BPA-(2)(2)A-G(7)(7)(7)-(8)(9)		100 002					
A22NL-BPM-(2)(2)A-G(7)(7)(7)-(8)(9)		A22NL-BPA-(2)(2)A-G(7)(7)(7)-(8)(9)	101 102 202							
	1	A22NL-MPM-(2)(2)A-G(7)(7)(7)-(8)(9)	A22NL-MPA-(2)(2)A-G(7)(7)(7)-(8)(9)		TR: Transparent, red TG: Transparent, green TY: Transparent, yellow TW: Transparent, white TA: Transparent, blue TO: Transparent, orange			100 002	R: Red G: Green Y: Yellow W: White A: Blue O: Orange	A: 6 VAC/DC B: 12 VAC/DC C: 24 VAC/DC D: 100/110/120 VAC E: 200/220/230/240 VAC
		A22NL-MPM-(2)(2)A-G(7)(7)(7)-(8)(9)	A22NL-MPA-(2)(2)A-G(7)(7)(7)-(8)(9)							
	2	A22NL-MPM-(2)(2)A-G(7)(7)(7)-(8)(9)	A22NL-MPA-(2)(2)A-G(7)(7)(7)-(8)(9)					100 002		
A22NL-MPM-(2)(2)A-G(7)(7)(7)-(8)(9)		A22NL-MPA-(2)(2)A-G(7)(7)(7)-(8)(9)	101 102 202							
	1	A22NL-RPM-(2)(2)A-G(7)(7)(7)-(8)(9)	A22NL-RPA-(2)(2)A-G(7)(7)(7)-(8)(9)					TR: Transparent, red TG: Transparent, green TY: Transparent, yellow TW: Transparent, white TA: Transparent, blue TO: Transparent, orange		
		A22NL-RPM-(2)(2)A-G(7)(7)(7)-(8)(9)	A22NL-RPA-(2)(2)A-G(7)(7)(7)-(8)(9)	101 102 202						
	2	A22NL-RPM-(2)(2)A-G(7)(7)(7)-(8)(9)	A22NL-RPA-(2)(2)A-G(7)(7)(7)-(8)(9)	100 002						
A22NL-RPM-(2)(2)A-G(7)(7)(7)-(8)(9)		A22NL-RPA-(2)(2)A-G(7)(7)(7)-(8)(9)	101 102 202							

Note: Normally, the Button and LED Lamp with the same color are combined.

However, opaque white is available by combining a white Button and yellow LED. A22N□-□□□-TWA-G□□□-Y□

■ Subassemblies: Refer to pages 8 to 12.
(You can order Operation Units, LED Lamps, Mounting Collars, and Contact Blocks individually.)



■ Specifications: Refer to page 15. ■ Dimensions: Refer to page 17.
■ Accessories and tools: Refer to page 13.

A22NN/A22NL



Ordering Information

Model Numbers for Sets - - - Shipped as a set that includes the Operation Unit, LED Lamp, Mounting Collar, and Contact Block.

Non-lighted, Full-guard Switches

Appearance	Contacts	Momentary action (self-resetting)	Alternate action (self-holding)	(2)(2) Button color	(7)(7)(7) Contacts
		Model	Model		
Plastic bezels 	1	A22NN-BGM-(2)(2)A-G(7)(7)-NN	A22NN-BGA-(2)(2)A-G(7)(7)-NN	NR: Opaque, red NG: Opaque, green NY: Opaque, yellow NW: Opaque, white NA: Opaque, blue NB: Opaque, black UR: Transparent, red UG: Transparent, green UY: Transparent, yellow UW: Transparent, white UA: Transparent, blue UO: Transparent, orange	100 002
	2	A22NN-BGM-(2)(2)A-G(7)(7)-NN	A22NN-BGA-(2)(2)A-G(7)(7)-NN		101 102 202
	3	A22NN-BGM-(2)(2)A-G(7)(7)-NN	A22NN-BGA-(2)(2)A-G(7)(7)-NN		111 112 122 222
Brushed metal bezels 	1	A22NN-MGM-(2)(2)A-G(7)(7)-NN	A22NN-MGA-(2)(2)A-G(7)(7)-NN		100 002
	2	A22NN-MGM-(2)(2)A-G(7)(7)-NN	A22NN-MGA-(2)(2)A-G(7)(7)-NN		101 102 202
	3	A22NN-MGM-(2)(2)A-G(7)(7)-NN	A22NN-MGA-(2)(2)A-G(7)(7)-NN		111 112 122 222

Lighted, Full-guard Switches

Appearance	Contacts	Momentary action (self-resetting)	Alternate action (self-holding)	(2)(2) Button color	(7)(7)(7) Contacts	(8) LED Lamp color	(9) LED Lamp voltage
		Model	Model				
Plastic bezels 	1	A22NL-BGM-(2)(2)A-G(7)(7)-(8)(9)	A22NL-BGA-(2)(2)A-G(7)(7)-(8)(9)	TR: Transparent, red TG: Transparent, green TY: Transparent, yellow TW: Transparent, white TA: Transparent, blue TO: Transparent, orange	100 002	R: Red G: Green Y: Yellow W: White A: Blue O: Orange	A: 6 VAC/DC B: 12 VAC/DC C: 24 VAC/DC D: 100/110/120 VAC E: 200/220/230/240 VAC
		A22NL-BGM-(2)(2)A-G(7)(7)-(8)(9)	A22NL-BGA-(2)(2)A-G(7)(7)-(8)(9)				
	2	A22NL-BGM-(2)(2)A-G(7)(7)-(8)(9)	A22NL-BGA-(2)(2)A-G(7)(7)-(8)(9)		101 102 202		
		A22NL-BGM-(2)(2)A-G(7)(7)-(8)(9)	A22NL-BGA-(2)(2)A-G(7)(7)-(8)(9)				
Brushed metal bezels 	1	A22NL-MGM-(2)(2)A-G(7)(7)-(8)(9)	A22NL-MGA-(2)(2)A-G(7)(7)-(8)(9)	100 002			
		A22NL-MGM-(2)(2)A-G(7)(7)-(8)(9)	A22NL-MGA-(2)(2)A-G(7)(7)-(8)(9)				
	2	A22NL-MGM-(2)(2)A-G(7)(7)-(8)(9)	A22NL-MGA-(2)(2)A-G(7)(7)-(8)(9)	101 102 202			
		A22NL-MGM-(2)(2)A-G(7)(7)-(8)(9)	A22NL-MGA-(2)(2)A-G(7)(7)-(8)(9)				

Note: Normally, the Button and LED Lamp with the same color are combined.

However, opaque white is available by combining a white Button and yellow LED. A22N□-□□□-IWA-G□□□-Y□



■ Subassemblies: Refer to pages 8 to 12.
(You can order Operation Units, LED Lamps, Mounting Collars, and Contact Blocks individually.)

■ Specifications: Refer to page 15. ■ Dimensions: Refer to page 17.
■ Accessories and tools: Refer to page 13.



Ordering Information

Model Numbers for Sets - - - Shipped as a set that includes the Operation Unit, LED Lamp, Mounting Collar, and Contact Block.

Non-lighted, Mushroom Switches

Appearance	Contacts	Momentary action (self-resetting)	Alternate action (self-holding)	(2)(2) Button color	(7)(7)(7) Contacts
		Model	Model		
Plastic bezels 	1	A22NN-BMM-(2)(2)A-G(7)(7)(7)-NN	A22NN-BMA-(2)(2)A-G(7)(7)(7)-NN	NR: Opaque, red NG: Opaque, green NY: Opaque, yellow NW: Opaque, white NA: Opaque, blue NB: Opaque, black UR: Transparent, red UG: Transparent, green UY: Transparent, yellow UW: Transparent, white UA: Transparent, blue UO: Transparent, orange	100 002
	2	A22NN-BMM-(2)(2)A-G(7)(7)(7)-NN	A22NN-BMA-(2)(2)A-G(7)(7)(7)-NN		101 102 202
	3	A22NN-BMM-(2)(2)A-G(7)(7)(7)-NN	A22NN-BMA-(2)(2)A-G(7)(7)(7)-NN		111 112 122 222
Brushed metal bezels 	1	A22NN-MMM-(2)(2)A-G(7)(7)(7)-NN	A22NN-MMA-(2)(2)A-G(7)(7)(7)-NN		100 002
	2	A22NN-MMM-(2)(2)A-G(7)(7)(7)-NN	A22NN-MMA-(2)(2)A-GáF(7)(7)(7)-NN		101 102 202
	3	A22NN-MMM-(2)(2)A-G(7)(7)(7)-NN	A22NN-MMA-(2)(2)A-G(7)(7)(7)-NN		111 112 122 222
Metal bezels 	1	A22NN-RMM-(2)(2)A-G(7)(7)(7)-NN	A22NN-RMA-(2)(2)A-G(7)(7)(7)-NN		100 002
	2	A22NN-RMM-(2)(2)A-G(7)(7)(7)-NN	A22NN-RMA-(2)(2)A-G(7)(7)(7)-NN		101 102 202
	3	A22NN-RMM-(2)(2)A-G(7)(7)(7)-NN	A22NN-RMA-(2)(2)A-G(7)(7)(7)-NN		111 112 122 222

Lighted, Mushroom Switches

Appearance	Contacts	Momentary action (self-resetting)	Alternate action (self-holding)	(2)(2) Button color	(7)(7)(7) Contacts	(8) LED Lamp color	(9) LED Lamp voltage
		Model	Model				
Plastic bezels 	1	A22NL-BMM-(2)(2)A-G(7)(7)(7)-(8)(9)	A22NL-BMA-(2)(2)A-G(7)(7)(7)-(8)(9)	TR: Transparent, red TG: Transparent, green TY: Transparent, yellow TW: Transparent, white TA: Transparent, blue TO: Transparent, orange	100 002	R: Red G: Green Y: Yellow W: White A: Blue O: Orange	A: 6 VAC/DC B: 12 VAC/DC C: 24 VAC/DC D: 100/110/120 VAC E: 200/220/230/240 VAC
		A22NL-BMM-(2)(2)A-G(7)(7)(7)-(8)(9)	A22NL-BMA-(2)(2)A-G(7)(7)(7)-(8)(9)				
	2	A22NL-BMM-(2)(2)A-G(7)(7)(7)-(8)(9)	A22NL-BMA-(2)(2)A-G(7)(7)(7)-(8)(9)		101 102 202		
		A22NL-BMM-(2)(2)A-G(7)(7)(7)-(8)(9)	A22NL-BMA-(2)(2)A-G(7)(7)(7)-(8)(9)				
Brushed metal bezels 	1	A22NL-MMM-(2)(2)A-G(7)(7)(7)-(8)(9)	A22NL-MMA-(2)(2)A-G(7)(7)(7)-(8)(9)		100 002		
		A22NL-MMM-(2)(2)A-G(7)(7)(7)-(8)(9)	A22NL-MMA-(2)(2)A-G(7)(7)(7)-(8)(9)				
	2	A22NL-MMM-(2)(2)A-G(7)(7)(7)-(8)(9)	A22NL-MMA-(2)(2)A-G(7)(7)(7)-(8)(9)		101 102 202		
		A22NL-MMM-(2)(2)A-G(7)(7)(7)-(8)(9)	A22NL-MMA-(2)(2)A-G(7)(7)(7)-(8)(9)				
Metal bezels 	1	A22NL-RMM-(2)(2)A-G(7)(7)(7)-(8)(9)	A22NL-RMA-(2)(2)A-G(7)(7)(7)-(8)(9)	100 002			
		A22NL-RMM-(2)(2)A-G(7)(7)(7)-(8)(9)	A22NL-RMA-(2)(2)A-G(7)(7)(7)-(8)(9)				
	2	A22NL-RMM-(2)(2)A-G(7)(7)(7)-(8)(9)	A22NL-RMA-(2)(2)A-G(7)(7)(7)-(8)(9)	101 102 202			
		A22NL-RMM-(2)(2)A-G(7)(7)(7)-(8)(9)	A22NL-RMA-(2)(2)A-G(7)(7)(7)-(8)(9)				

Note: Normally, the Button and LED Lamp with the same color are combined.
 However, opaque white is available by combining a white Button and yellow LED. A22N□-□□□-TWA-G□□□-Y□

■ Subassemblies: Refer to pages 8 to 12.
 (You can order Operation Units, LED Lamps, Mounting Collars, and Contact Blocks individually.)

■ Specifications: Refer to page 15. ■ Dimensions: Refer to page 17.
 ■ Accessories and tools: Refer to page 13.

Ordering Information

Switch Structure - - - You can order Operation Units, LED Lamp, Mounting Collars, and Contact Blocks individually. Use them in combination for models that are not available as assembled Switches. They can also be used as inventory for maintenance parts.

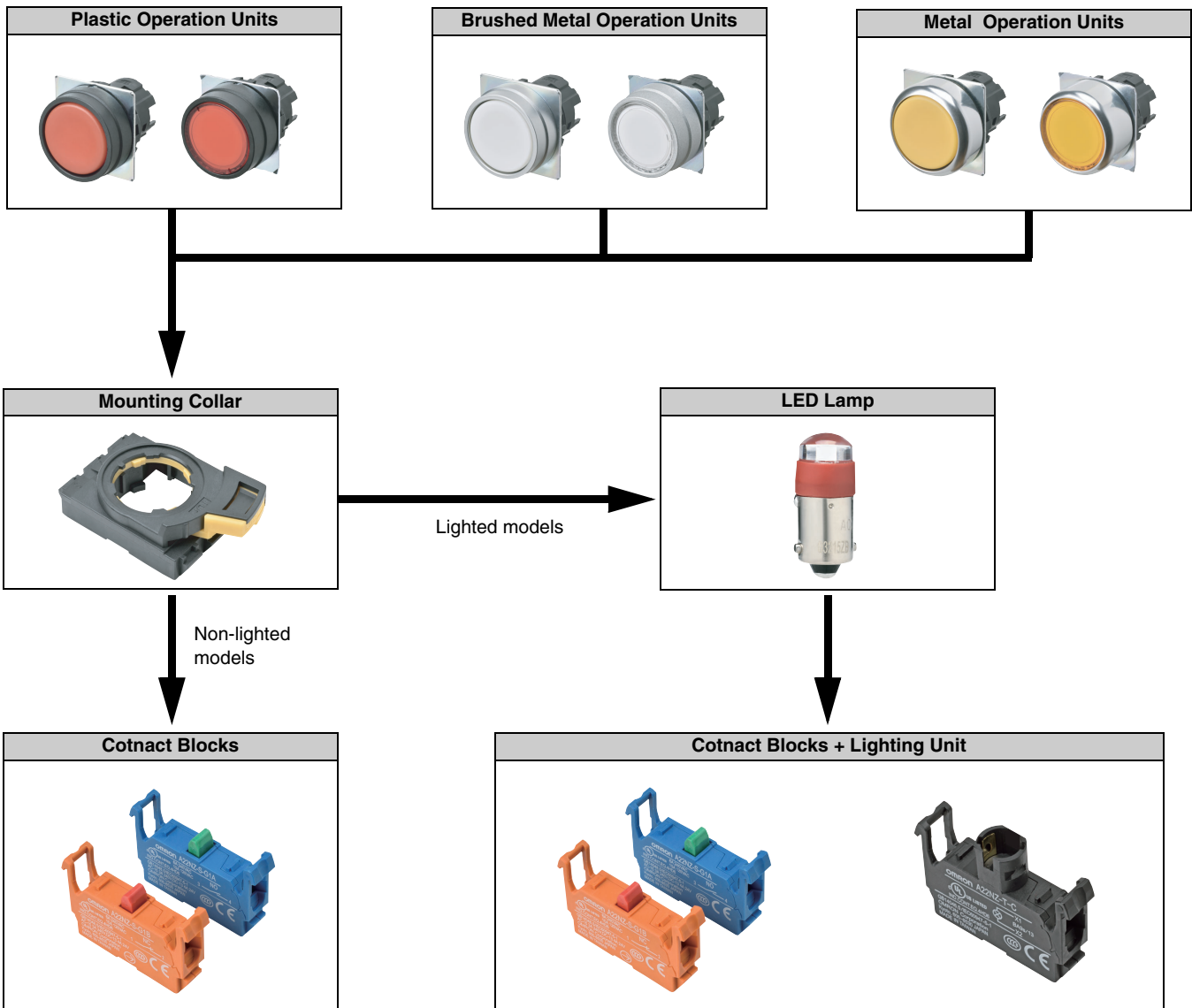

Note: Use a Reinforcement Plate for greater strength.



■ Model numbers of sets: Refer to pages 4 to 7.

■ Specifications: Refer to page 15. ■ Dimensions: Refer to page 17.
 ■ Accessories and tools: Refer to page 13.

Ordering Information

Subassemblies

----- You can order Operation Units, LED Lamps, Mounting Collars, and Contact Blocks individually. Use them in combination for models that are not available as assembled Switches. They can also be used as inventory for maintenance parts.

Operation Units

Bezel material and button shape			Plastic, flat		Plastic, projected	
			Switch Action		Momentary	Alternate
Lighted/ non-lighted	Transparency	Color	Model	Model	Model	Model
			Non-lighted	Opaque	Red	A22NZ-BNM-NRA
Opaque	Green	A22NZ-BNM-NGA		A22NZ-BNA-NGA	A22NZ-BPM-NGA	A22NZ-BPA-NGA
Opaque	Yellow	A22NZ-BNM-NYA		A22NZ-BNA-NYA	A22NZ-BPM-NYA	A22NZ-BPA-NYA
Opaque	White	A22NZ-BNM-NWA		A22NZ-BNA-NWA	A22NZ-BPM-NWA	A22NZ-BPA-NWA
Opaque	Blue	A22NZ-BNM-NAA		A22NZ-BNA-NAA	A22NZ-BPM-NAA	A22NZ-BPA-NAA
Opaque	Black	A22NZ-BNM-NBA		A22NZ-BNA-NBA	A22NZ-BPM-NBA	A22NZ-BPA-NBA
Transparent	Red	A22NZ-BNM-URA		A22NZ-BNA-URA	A22NZ-BPM-URA	A22NZ-BPA-URA
Transparent	Green	A22NZ-BNM-UGA		A22NZ-BNA-UGA	A22NZ-BPM-UGA	A22NZ-BPA-UGA
Transparent	Yellow	A22NZ-BNM-UYA		A22NZ-BNA-UYA	A22NZ-BPM-UYA	A22NZ-BPA-UYA
Transparent	White	A22NZ-BNM-UWA		A22NZ-BNA-UWA	A22NZ-BPM-UWA	A22NZ-BPA-UWA
Transparent	Blue	A22NZ-BNM-UAA		A22NZ-BNA-UAA	A22NZ-BPM-UAA	A22NZ-BPA-UAA
Lighted	Transparent	Orange	A22NZ-BNM-UOA	A22NZ-BNA-UOA	A22NZ-BPM-UOA	A22NZ-BPA-UOA
	Transparent	Red	A22NZ-BNM-TRA	A22NZ-BNA-TRA	A22NZ-BPM-TRA	A22NZ-BPA-TRA
	Transparent	Green	A22NZ-BNM-TGA	A22NZ-BNA-TGA	A22NZ-BPM-TGA	A22NZ-BPA-TGA
	Transparent	Yellow	A22NZ-BNM-TYA	A22NZ-BNA-TYA	A22NZ-BPM-TYA	A22NZ-BPA-TYA
	Transparent	White	A22NZ-BNM-TWA	A22NZ-BNA-TWA	A22NZ-BPM-TWA	A22NZ-BPA-TWA
	Transparent	Blue	A22NZ-BNM-TAA	A22NZ-BNA-TAA	A22NZ-BPM-TAA	A22NZ-BPA-TAA
Transparent	Orange	A22NZ-BNM-TOA	A22NZ-BNA-TOA	A22NZ-BPM-TOA	A22NZ-BPA-TOA	

Bezel material and button shape			Plastic, full-guard		Plastic, mushroom	
			Switch Action		Momentary	Alternate
Lighted/ non-lighted	Transparency	Color	Model	Model	Model	Model
			Non-lighted	Opaque	Red	A22NZ-BGM-NRA
Opaque	Green	A22NZ-BGM-NGA		A22NZ-BGA-NGA	A22NZ-BMM-NGA	A22NZ-BMA-NGA
Opaque	Yellow	A22NZ-BGM-NYA		A22NZ-BGA-NYA	A22NZ-BMM-NYA	A22NZ-BMA-NYA
Opaque	White	A22NZ-BGM-NWA		A22NZ-BGA-NWA	A22NZ-BMM-NWA	A22NZ-BMA-NWA
Opaque	Blue	A22NZ-BGM-NAA		A22NZ-BGA-NAA	A22NZ-BMM-NAA	A22NZ-BMA-NAA
Opaque	Black	A22NZ-BGM-NBA		A22NZ-BGA-NBA	A22NZ-BMM-NBA	A22NZ-BMA-NBA
Transparent	Red	A22NZ-BGM-URA		A22NZ-BGA-URA	A22NZ-BMM-URA	A22NZ-BMA-URA
Transparent	Green	A22NZ-BGM-UGA		A22NZ-BGA-UGA	A22NZ-BMM-UGA	A22NZ-BMA-UGA
Transparent	Yellow	A22NZ-BGM-UYA		A22NZ-BGA-UYA	A22NZ-BMM-UYA	A22NZ-BMA-UYA
Transparent	White	A22NZ-BGM-UWA		A22NZ-BGA-UWA	A22NZ-BMM-UWA	A22NZ-BMA-UWA
Transparent	Blue	A22NZ-BGM-UAA		A22NZ-BGA-UAA	A22NZ-BMM-UAA	A22NZ-BMA-UAA
Lighted	Transparent	Orange	A22NZ-BGM-UOA	A22NZ-BGA-UOA	A22NZ-BMM-UOA	A22NZ-BMA-UOA
	Transparent	Red	A22NZ-BGM-TRA	A22NZ-BGA-TRA	A22NZ-BMM-TRA	A22NZ-BMA-TRA
	Transparent	Green	A22NZ-BGM-TGA	A22NZ-BGA-TGA	A22NZ-BMM-TGA	A22NZ-BMA-TGA
	Transparent	Yellow	A22NZ-BGM-TYA	A22NZ-BGA-TYA	A22NZ-BMM-TYA	A22NZ-BMA-TYA
	Transparent	White	A22NZ-BGM-TWA	A22NZ-BGA-TWA	A22NZ-BMM-TWA	A22NZ-BMA-TWA
	Transparent	Blue	A22NZ-BGM-TAA	A22NZ-BGA-TAA	A22NZ-BMM-TAA	A22NZ-BMA-TAA
Transparent	Orange	A22NZ-BGM-TOA	A22NZ-BGA-TOA	A22NZ-BMM-TOA	A22NZ-BMA-TOA	

■ Model numbers of sets: Refer to pages 4 to 7.

■ Specifications: Refer to page 15. ■ Dimensions: Refer to page 17.
 ■ Accessories and tools: Refer to page 13.

Ordering Information

Subassemblies

----- You can order Operation Units, LED Lamps, Mounting Collars, and Contact Blocks individually. Use them in combination for models that are not available as assembled Switches. They can also be used as inventory for maintenance parts.

Bezel material and button shape			Brushed metal, flat		Brushed metal, projected	
						
Lighted/ non-lighted	Switch Action		Momentary	Alternate	Momentary	Alternate
	Transparency	Color	Model	Model	Model	Model
Non-lighted	Opaque	Red	A22NZ-MNM-NRA	A22NZ-MNA-NRA	A22NZ-MPM-NRA	A22NZ-MPA-NRA
	Opaque	Green	A22NZ-MNM-NGA	A22NZ-MNA-NGA	A22NZ-MPM-NGA	A22NZ-MPA-NGA
	Opaque	Yellow	A22NZ-MNM-NYA	A22NZ-MNA-NYA	A22NZ-MPM-NYA	A22NZ-MPA-NYA
	Opaque	White	A22NZ-MNM-NWA	A22NZ-MNA-NWA	A22NZ-MPM-NWA	A22NZ-MPA-NWA
	Opaque	Blue	A22NZ-MNM-NAA	A22NZ-MNA-NAA	A22NZ-MPM-NAA	A22NZ-MPA-NAA
	Opaque	Black	A22NZ-MNM-NBA	A22NZ-MNA-NBA	A22NZ-MPM-NBA	A22NZ-MPA-NBA
	Transparent	Red	A22NZ-MNM-URA	A22NZ-MNA-URA	A22NZ-MPM-URA	A22NZ-MPA-URA
	Transparent	Green	A22NZ-MNM-UGA	A22NZ-MNA-UGA	A22NZ-MPM-UGA	A22NZ-MPA-UGA
	Transparent	Yellow	A22NZ-MNM-UYA	A22NZ-MNA-UYA	A22NZ-MPM-UYA	A22NZ-MPA-UYA
	Transparent	White	A22NZ-MNM-UWA	A22NZ-MNA-UWA	A22NZ-MPM-UWA	A22NZ-MPA-UWA
	Transparent	Blue	A22NZ-MNM-UAA	A22NZ-MNA-UAA	A22NZ-MPM-UAA	A22NZ-MPA-UAA
Lighted	Transparent	Red	A22NZ-MNM-TRA	A22NZ-MNA-TRA	A22NZ-MPM-TRA	A22NZ-MPA-TRA
	Transparent	Green	A22NZ-MNM-TGA	A22NZ-MNA-TGA	A22NZ-MPM-TGA	A22NZ-MPA-TGA
	Transparent	Yellow	A22NZ-MNM-TYA	A22NZ-MNA-TYA	A22NZ-MPM-TYA	A22NZ-MPA-TYA
	Transparent	White	A22NZ-MNM-TWA	A22NZ-MNA-TWA	A22NZ-MPM-TWA	A22NZ-MPA-TWA
	Transparent	Blue	A22NZ-MNM-TAA	A22NZ-MNA-TAA	A22NZ-MPM-TAA	A22NZ-MPA-TAA
	Transparent	Orange	A22NZ-MNM-TOA	A22NZ-MNA-TOA	A22NZ-MPM-TOA	A22NZ-MPA-TOA

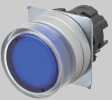
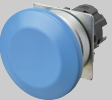
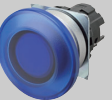
Bezel material and button shape			Brushed metal, full-guard		Brushed metal, mushroom	
						
Lighted/ non-lighted	Switch Action		Momentary	Alternate	Momentary	Alternate
	Transparency	Color	Model	Model	Model	Model
Non-lighted	Opaque	Red	A22NZ-MGM-NRA	A22NZ-MGA-NRA	A22NZ-MMM-NRA	A22NZ-MMA-NRA
	Opaque	Green	A22NZ-MGM-NGA	A22NZ-MGA-NGA	A22NZ-MMM-NGA	A22NZ-MMA-NGA
	Opaque	Yellow	A22NZ-MGM-NYA	A22NZ-MGA-NYA	A22NZ-MMM-NYA	A22NZ-MMA-NYA
	Opaque	White	A22NZ-MGM-NWA	A22NZ-MGA-NWA	A22NZ-MMM-NWA	A22NZ-MMA-NWA
	Opaque	Blue	A22NZ-MGM-NAA	A22NZ-MGA-NAA	A22NZ-MMM-NAA	A22NZ-MMA-NAA
	Opaque	Black	A22NZ-MGM-NBA	A22NZ-MGA-NBA	A22NZ-MMM-NBA	A22NZ-MMA-NBA
	Transparent	Red	A22NZ-MGM-URA	A22NZ-MGA-URA	A22NZ-MMM-URA	A22NZ-MMA-URA
	Transparent	Green	A22NZ-MGM-UGA	A22NZ-MGA-UGA	A22NZ-MMM-UGA	A22NZ-MMA-UGA
	Transparent	Yellow	A22NZ-MGM-UYA	A22NZ-MGA-UYA	A22NZ-MMM-UYA	A22NZ-MMA-UYA
	Transparent	White	A22NZ-MGM-UWA	A22NZ-MGA-UWA	A22NZ-MMM-UWA	A22NZ-MMA-UWA
	Transparent	Blue	A22NZ-MGM-UAA	A22NZ-MGA-UAA	A22NZ-MMM-UAA	A22NZ-MMA-UAA
Lighted	Transparent	Red	A22NZ-MGM-TRA	A22NZ-MGA-TRA	A22NZ-MMM-TRA	A22NZ-MMA-TRA
	Transparent	Green	A22NZ-MGM-TGA	A22NZ-MGA-TGA	A22NZ-MMM-TGA	A22NZ-MMA-TGA
	Transparent	Yellow	A22NZ-MGM-TYA	A22NZ-MGA-TYA	A22NZ-MMM-TYA	A22NZ-MMA-TYA
	Transparent	White	A22NZ-MGM-TWA	A22NZ-MGA-TWA	A22NZ-MMM-TWA	A22NZ-MMA-TWA
	Transparent	Blue	A22NZ-MGM-TAA	A22NZ-MGA-TAA	A22NZ-MMM-TAA	A22NZ-MMA-TAA
	Transparent	Orange	A22NZ-MGM-TOA	A22NZ-MGA-TOA	A22NZ-MMM-TOA	A22NZ-MMA-TOA

■ Model numbers of sets: Refer to pages 4 to 7.

■ Specifications: Refer to page 15. ■ Dimensions: Refer to page 17.

■ Accessories and tools: Refer to page 13.

Ordering Information

Subassemblies

----- You can order Operation Units, LED Lamps, Mounting Collars, and Contact Blocks individually. Use them in combination for models that are not available as assembled Switches. They can also be used as inventory for maintenance parts.

Bezel material and button shape			Metal, flat		Metal, projected	
						
Lighted/ non-lighted	Switch Action		Momentary	Alternate	Momentary	Alternate
	Transparency	Color	Model	Model	Model	Model
Non-lighted	Opaque	Red	A22NZ-RNM-NRA	A22NZ-RNA-NRA	A22NZ-RPM-NRA	A22NZ-RPA-NRA
	Opaque	Green	A22NZ-RNM-NGA	A22NZ-RNA-NGA	A22NZ-RPM-NGA	A22NZ-RPA-NGA
	Opaque	Yellow	A22NZ-RNM-NYA	A22NZ-RNA-NYA	A22NZ-RPM-NYA	A22NZ-RPA-NYA
	Opaque	White	A22NZ-RNM-NWA	A22NZ-RNA-NWA	A22NZ-RPM-NWA	A22NZ-RPA-NWA
	Opaque	Blue	A22NZ-RNM-NAA	A22NZ-RNA-NAA	A22NZ-RPM-NAA	A22NZ-RPA-NAA
	Opaque	Black	A22NZ-RNM-NBA	A22NZ-RNA-NBA	A22NZ-RPM-NBA	A22NZ-RPA-NBA
	Transparent	Red	A22NZ-RNM-URA	A22NZ-RNA-URA	A22NZ-RPM-URA	A22NZ-RPA-URA
	Transparent	Green	A22NZ-RNM-UGA	A22NZ-RNA-UGA	A22NZ-RPM-UGA	A22NZ-RPA-UGA
	Transparent	Yellow	A22NZ-RNM-UYA	A22NZ-RNA-UYA	A22NZ-RPM-UYA	A22NZ-RPA-UYA
	Transparent	White	A22NZ-RNM-UWA	A22NZ-RNA-UWA	A22NZ-RPM-UWA	A22NZ-RPA-UWA
	Transparent	Blue	A22NZ-RNM-UAA	A22NZ-RNA-UAA	A22NZ-RPM-UAA	A22NZ-RPA-UAA
	Transparent	Orange	A22NZ-RNM-UOA	A22NZ-RNA-UOA	A22NZ-RPM-UOA	A22NZ-RPA-UOA
Lighted	Transparent	Red	A22NZ-RNM-TRA	A22NZ-RNA-TRA	A22NZ-RPM-TRA	A22NZ-RPA-TRA
	Transparent	Green	A22NZ-RNM-TGA	A22NZ-RNA-TGA	A22NZ-RPM-TGA	A22NZ-RPA-TGA
	Transparent	Yellow	A22NZ-RNM-TYA	A22NZ-RNA-TYA	A22NZ-RPM-TYA	A22NZ-RPA-TYA
	Transparent	White	A22NZ-RNM-TWA	A22NZ-RNA-TWA	A22NZ-RPM-TWA	A22NZ-RPA-TWA
	Transparent	Blue	A22NZ-RNM-TAA	A22NZ-RNA-TAA	A22NZ-RPM-TAA	A22NZ-RPA-TAA
	Transparent	Orange	A22NZ-RNM-TOA	A22NZ-RNA-TOA	A22NZ-RPM-TOA	A22NZ-RPA-TOA

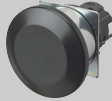
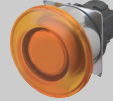
Bezel material and button shape			Metal, mushroom	
				
Lighted/ non-lighted	Switch Action		Momentary	Alternate
	Transparency	Color	Model	Model
Non-lighted	Opaque	Red	A22NZ-RMM-NRA	A22NZ-RMA-NRA
	Opaque	Green	A22NZ-RMM-NGA	A22NZ-RMA-NGA
	Opaque	Yellow	A22NZ-RMM-NYA	A22NZ-RMA-NYA
	Opaque	White	A22NZ-RMM-NWA	A22NZ-RMA-NWA
	Opaque	Blue	A22NZ-RMM-NAA	A22NZ-RMA-NAA
	Opaque	Black	A22NZ-RMM-NBA	A22NZ-RMA-NBA
	Transparent	Red	A22NZ-RMM-URA	A22NZ-RMA-URA
	Transparent	Green	A22NZ-RMM-UGA	A22NZ-RMA-UGA
	Transparent	Yellow	A22NZ-RMM-UYA	A22NZ-RMA-UYA
	Transparent	White	A22NZ-RMM-UWA	A22NZ-RMA-UWA
	Transparent	Blue	A22NZ-RMM-UAA	A22NZ-RMA-UAA
	Transparent	Orange	A22NZ-RMM-UOA	A22NZ-RMA-UOA
Lighted	Transparent	Red	A22NZ-RMM-TRA	A22NZ-RMA-TRA
	Transparent	Green	A22NZ-RMM-TGA	A22NZ-RMA-TGA
	Transparent	Yellow	A22NZ-RMM-TYA	A22NZ-RMA-TYA
	Transparent	White	A22NZ-RMM-TWA	A22NZ-RMA-TWA
	Transparent	Blue	A22NZ-RMM-TAA	A22NZ-RMA-TAA
	Transparent	Orange	A22NZ-RMM-TOA	A22NZ-RMA-TOA

■ Model numbers of sets: Refer to pages 4 to 7.

■ Specifications: Refer to page 15. ■ Dimensions: Refer to page 17.
 ■ Accessories and tools: Refer to page 13.

A22NN/A22NL

Ordering Information

Subassemblies --- You can order Operation Units, LED Lamps, Mounting Collars, and Contact Blocks individually. Use them in combination for models that are not available as assembled Switches. They can also be used as inventory for maintenance parts.

LED Lamps

Appearance	Applied voltage	6 VAC/DC	12 VAC/DC	24 VAC/DC	100/110/120 VAC	200/220/230/240 VAC
	Color	Model	Model	Model	Model	Model
	Red	A22NZ-L-RA	A22NZ-L-RB	A22NZ-L-RC	A22NZ-L-RD	A22NZ-L-RE
	Green	A22NZ-L-GA	A22NZ-L-GB	A22NZ-L-GC	A22NZ-L-GD	A22NZ-L-GE
	Yellow	A22NZ-L-YA	A22NZ-L-YB	A22NZ-L-YC	A22NZ-L-YD	A22NZ-L-YE
	White	A22NZ-L-WA	A22NZ-L-WB	A22NZ-L-WC	A22NZ-L-WD	A22NZ-L-WE
	Blue	A22NZ-L-AA	A22NZ-L-AB	A22NZ-L-AC	A22NZ-L-AD	A22NZ-L-AE
	Orange	A22NZ-L-OA	A22NZ-L-OB	A22NZ-L-OC	A22NZ-L-OD	A22NZ-L-OE

Mounting Collar

Appearance	Model
	A22NZ-H-01

Contact Blocks

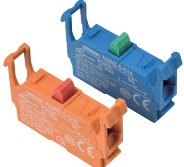
Appearance	Contacts	Model
	SPST-NO (blue)	A22NZ-S-G1A
	SPST-NC (orange)	A22NZ-S-G1B

Lighting Units







Appearance	Applied voltage	Model
	6 VAC/DC	A22NZ-T-A
	12 VAC/DC	A22NZ-T-B
	24 VAC/DC	A22NZ-T-C
	100/110/120 VAC	A22NZ-T-D
	200/220/230/240 VAC	A22NZ-T-E

Reinforcement Plate

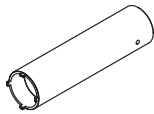
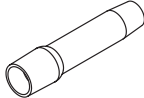
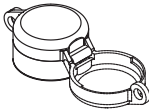

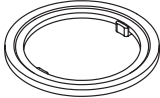
Appearance	Model
	A22NZ-A-C01

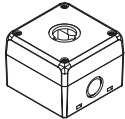
Ordering Information

Accessories and Tools (Order Separately)

Item	Appearance	Classification	Model	Remarks
Tightening Wrench		---	A22NZ-A-301	Used to tighten Mounting Nuts from the back of the panel.
LED Lamp Extractor		---	A22NZ-A-302	Made of rubber and used to easily remove and attach LED Lamps.
Protective Cover		---	A22NZ-A-303	A protector designed to prevent incorrect operation. Cannot be used together with other accessories. (Rubber seal included.)
Plastic Hole Plug		Round	A22NZ-A-401	Can be plugged into precut panel holes for future expansion. Applicable panel thickness: 0.8 to 3.0 mm For 22.3-mm panel hole diameter.
Metal Hole Plug		Round	A22NZ-A-402	Can be plugged into precut panel holes for future expansion. Applicable panel thickness: 0.8 to 6.0 mm (Rubber seal included.)
Lock Ring		Round	A22NZ-A-403	Used when a more secure lock is required to prevent rotation inside the Operation Unit. (Rubber seal included.) For 22.3-mm panel hole diameter.
Lock Ring		---	A22NZ-A-50501	Used when a more secure lock is required to prevent rotation of the Operation Unit.
Control Box		1 hole	A22NZ-A-B01Y	
Cap Tightening Wrench		---	A22Z-3908	Used to replace the Caps on Flat, Projected, and Full-guard Push-button Switches.

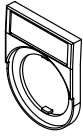
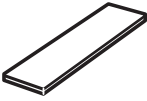
A22NN/A22NL

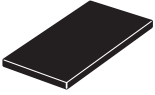
Item	Appearance	Classification	Model	Remarks
Small Legend Plate Frame		Black	A22NZ-A-50103	Legend Plate with no text on black background included. For 22.3-mm panel hole diameter.
Small Legend Plates		Without text	A22Z-3443B	Black
			A22Z-3443R	Red
			A22Z-3443W	White
			A22Z-3443C	Transparent
		○	A22Z-3443R-2	White text on red background
		STOP	A22Z-3443R-4	
		---	A22Z-3443B-1	Legend Plate with white text on black background included. For 22.3-mm panel hole diameter.
		START	A22Z-3443B-3	
		ON	A22Z-3443B-5	
		OFF	A22Z-3443B-6	
		UP	A22Z-3443B-7	
		DOWN	A22Z-3443B-8	
		POWER ON	A22Z-3443B-9	
OFF-ON	A22Z-3443B-10			
Large Legend Plate Frame		Black	A22NZ-A-51103	Legend Plate with no text on black background included. For 22.3-mm panel hole diameter.
Large Legend Plates		Without text	A22Z-3453B	Black
			A22Z-3453R	Red
			A22Z-3453W	White
			A22Z-3453C	Transparent

Specifications

Certified Safety Standard Ratings

UL 508 (File No. E76675), CSA C22.2 No.14

6 A 240 VAC, 10 A 120 VAC

TÜV (EN60947-5-1)

AC-15 3 A 240 VAC

DC-13 4 A 24 VDC

CCC (GB14048.5)

AC-15 3 A 240 VAC

DC-13 4 A 24 VDC

Ratings

Contacts (Standard Load)

Rated insulation voltage		600 V				
Rated carry current		10 A				
Applied voltage		24 V	120 V	240 V	380 V	440 V
AC at 50/60 Hz	Resistive load (AC-12)	10 A	10 A	6 A	2A	2 A
	Inductive load (AC-15)	10 A	6 A	3 A	1.9 A	1.6 A
DC	Resistive load (DC-12)	8 A	2.2 A	1.1 A	---	---
	Inductive load (DC-13)	4 A	1.1 A	0.55 A	---	---

Note: 1. The above ratings were obtained by conducting tests under the following conditions.

(1) Ambient temperature: 20 ±2°C

(2) Ambient humidity: 65% ±5% RH

(3) Operating frequency: 30 operations/minute

2. Minimum applicable load: 10 mA at 5 VDC.

LED Lamps

Rated voltage	Applied voltage	Rated current
6 VAC/DC	6 VAC/DC ±10%	Approx. 11 mA (red, orange, yellow, or blue)
		Approx. 5 mA (white or green)
12 VAC/DC	12 VAC/DC ±10%	Approx. 12 mA (red, orange, yellow, or blue)
		Approx. 5 mA (white or green)
24 VAC/DC	24 VAC/DC ±10%	Approx. 12 mA (red, orange, yellow, or blue)
		Approx. 5 mA (white or green)
100 VAC	100 VAC ±10%	Approx. 2 mA
110 VAC	110 VAC ±10%	
120 VAC	100 to 130 VAC	
200 VAC	200 VAC ±10%	Approx. 2 mA
220 VAC	220 VAC ±10%	
230 VAC	230 VAC ±10%	
240 VAC	220 to 250 VAC	

Specifications

Characteristics

Item	Type	Pushbutton Switches	
		Non-lighted models	Lighted models
Allowable operating frequency	Mechanical	60 operations/minute max.	
	Electrical	30 operations/minute max.	
Insulation resistance		100 MΩ min. (at 500 VDC)	
Contact resistance		100 mΩ max. (initial value)	
Dielectric strength	Between terminals of same polarity	2,500 VAC at 50/60 Hz for 1 min	
	Between each terminal and ground	2,500 VAC at 50/60 Hz for 1 min	
Vibration resistance	Malfunction	10 to 55 Hz, 1.5-mm double amplitude (malfunction within 1 ms)	
Shock resistance	Malfunction	1,000 m/s ² max. (malfunction within 1 ms)	
Durability	Mechanical	Momentary action: 5,000,000 operations min. Alternate action: 500,000 operations min.	
	Electrical	500,000 operations min.	
Ambient operating temperature ^{*1}		-25 to 70°C	-25 to 55°C
Ambient operating humidity		35% to 85% RH	
Ambient storage temperature ^{*1}		-40 to 80°C	
Degree of protection ^{*2}		IP66, NEMA 4X, NEMA13	
Electric shock protection class		Class II	
PTI (tracking characteristic)		175	
Degree of contamination (application environment)		3 (IEC 60947-5-1)	
Weight		Approx. 50 g (for 1NC/1NO)	Approx. 65 g (for 1NC/1NO)

*1. With no icing or condensation.

*2. Degree of protection from the front of the panel.

Operating Characteristics (for SPST-NO/SPST-NC)

Item	Type	Pushbutton Switches	
		Lighted/non-lighted	
Total travel force (torque) (maximum TTF)		18 N	
Total travel (TT)		6 mm max.	
Resetting force (torque) (RF)		---	

Examples of Linked Contact Blocks

Contact Blocks

Lighting Units

	Pushbutton Switches			
	Momentary		Alternate	
	Lighted	Non-lighted	Lighted	Non-lighted
Linking example				

Note: If you increase the number of Contact Blocks, evaluate the Switch under actual working conditions before permanent installation and use the Switch within a number of switching operations that will not adversely affect the Switch's performance.

Dimensions

Lighted and Non-lighted Pushbutton Switches

Flat Switches with Plastic Bezels

A22NN-BN□-N□A-G□-NN

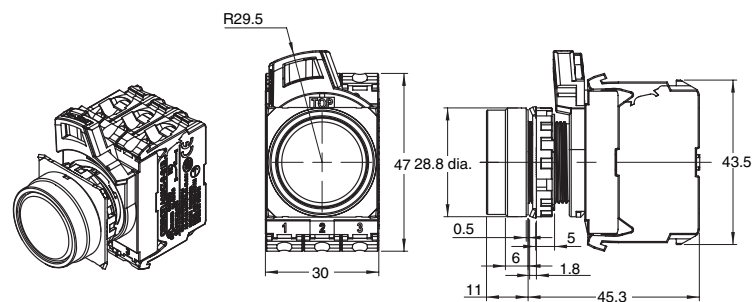

A22NL-BN□-T□A-G□-□□

A22NN-BN□-U□A-G□-NN

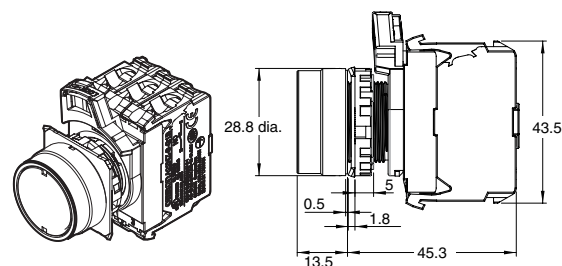

Projected Switches with Plastic Bezels

A22N□-BP□-□A-G□-□□

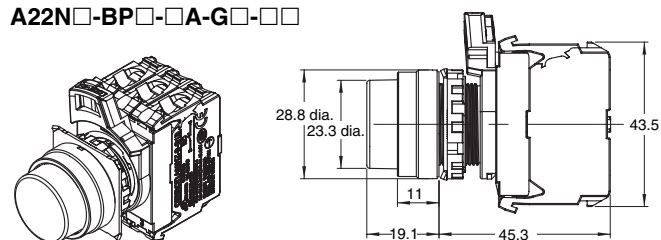

Full-guard Switches with Plastic Bezels

A22N□-BG□-□A-G□-□□

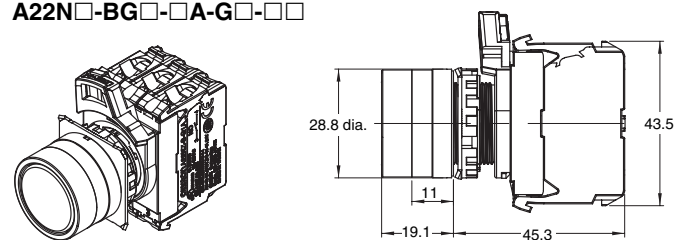

Mushroom Switches with Plastic Bezels

A22N□-BM□-□A-G□-□□

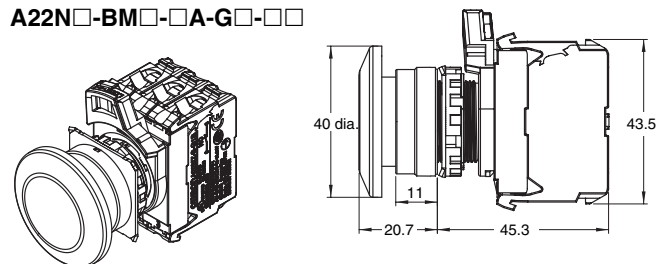

A22NN/A22NL

Dimensions

(Unit: mm)

Flat Switches with Brushed Metal Bezels

A22NN-MN□-N□A-G□-NN

A22NL-MN□-T□A-G□-□□

A22NN-MN□-U□A-G□-NN

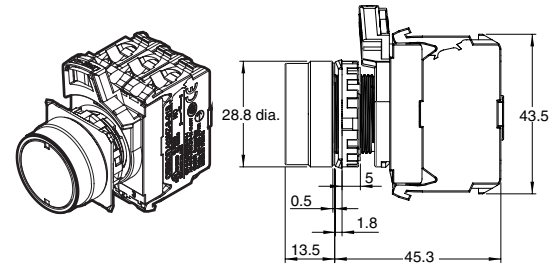
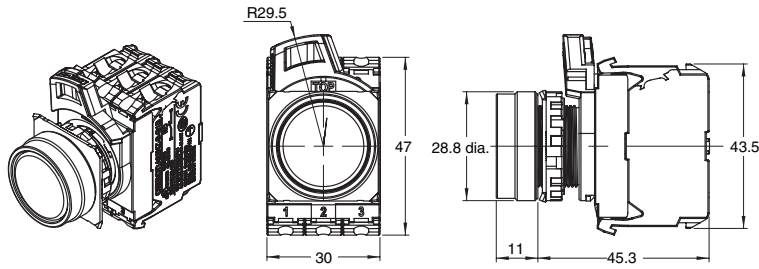

Projected Switches with Brushed Metal Bezels

A22N□-MP□-□A-G□-□□

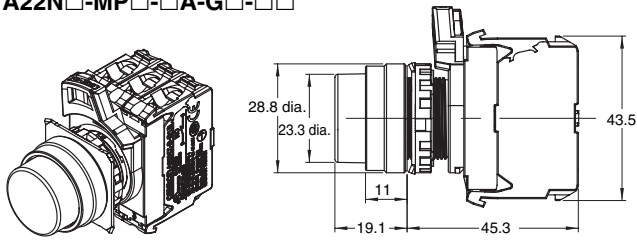

Full-guard Switches with Brushed Metal Bezels

A22N□-MG□-□A-G□-□□

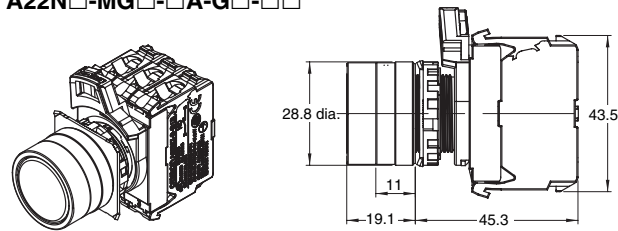

Mushroom Switches with Brushed Metal Bezels

A22N□-MM□-□A-G□-□□

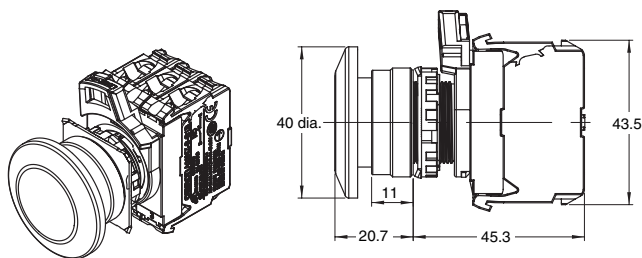

Dimensions

Flat Switches with Metal Bezels

A22NN-RN□-N□A-G□-NN

A22NL-RN□-T□A-G□-□□

A22NN-RN□-U□A-G□-NN

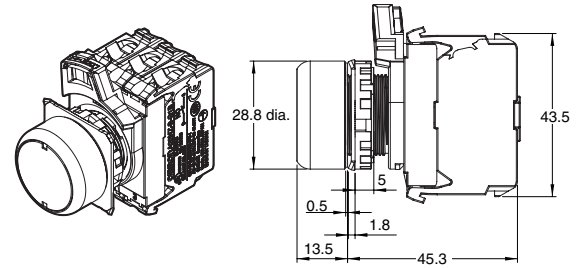
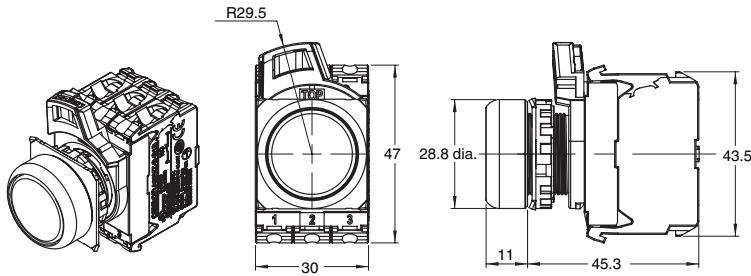

Projected Switches with Metal Bezels

A22N□-RP□-□A-G□-□□

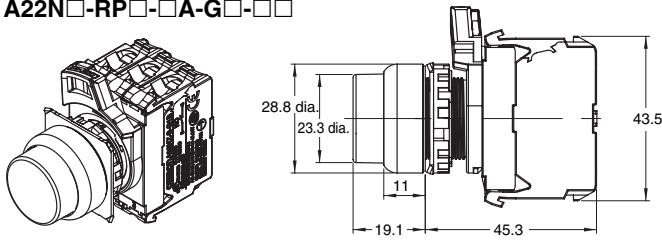

Mushroom Switches with Metal Bezels

A22N□-RM□-□A-G□-□□

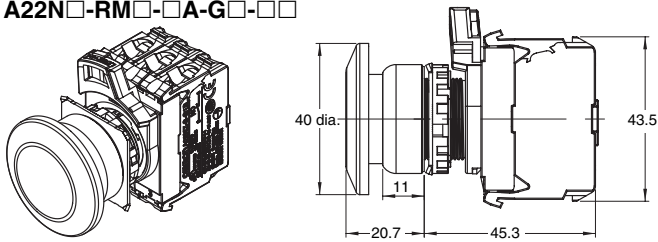

Depth with Linked Units

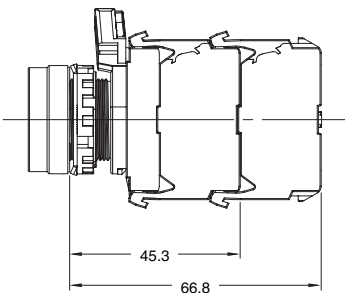

Terminal Wiring Diagrams

Bottom View

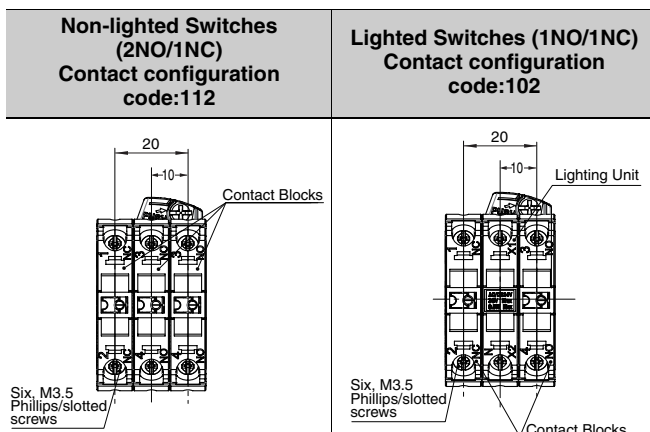

Terminal Connection Diagrams

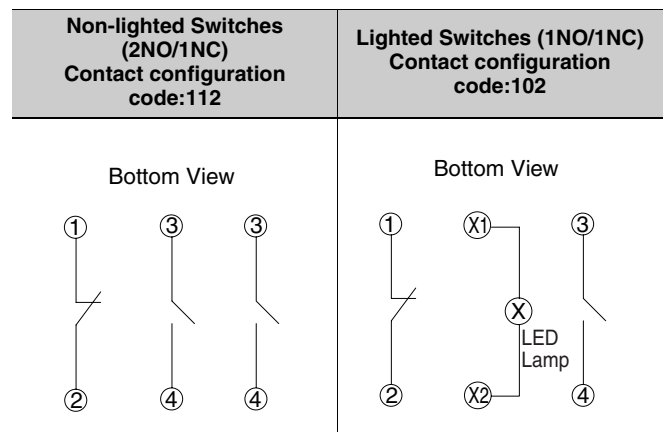

A22NN/A22NL

Dimensions

(Unit: mm)

LED Lamps A22NZ-L-□□

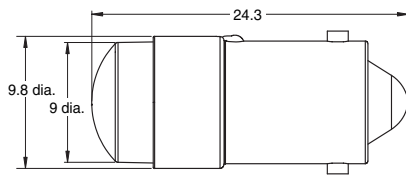
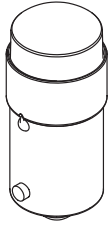

Mounting Collar A22NZ-H-01

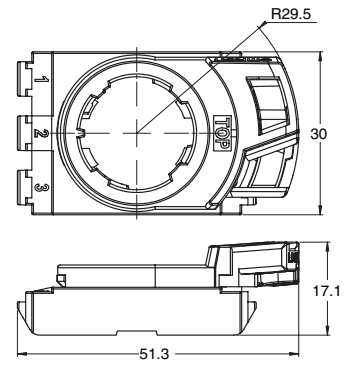
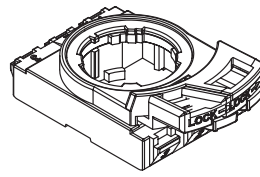

Contact Blocks A22NZ-S-G1□

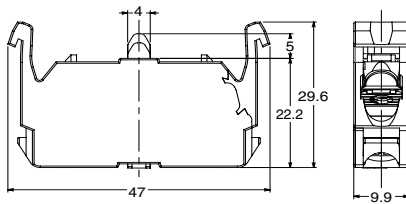
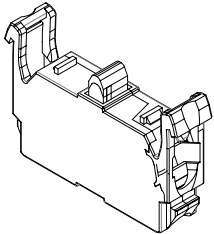

Lighting Units A22NZ-Z-□

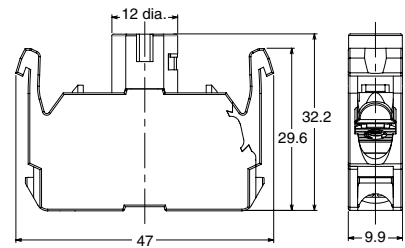
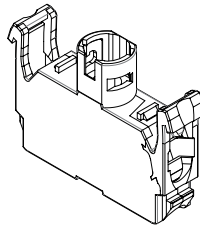

Reinforcement Plate A22NZ-A-C01

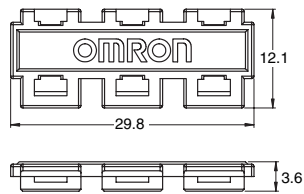
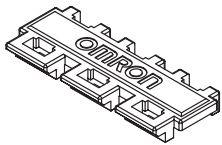

Dimensions

(Unit: mm)

Dimensions of Accessories

Tightening Wrench
A22NZ-A-301

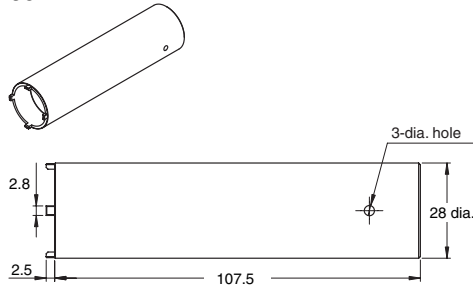

LED Extractor
A22NZ-A-302

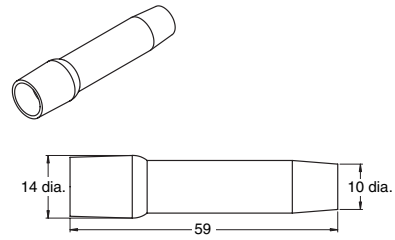

Protective Cover
A22NZ-A303

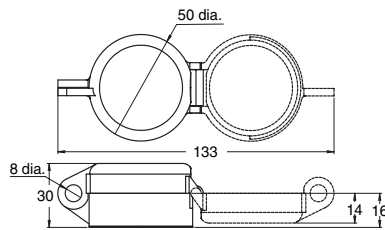
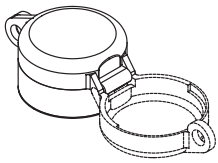

Plastic Hole Plug
A22NZ-A-401

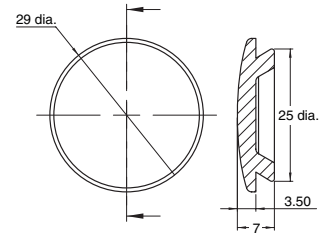
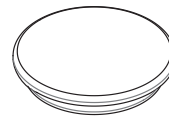

Metal Hole Plug
A22NZ-A-402

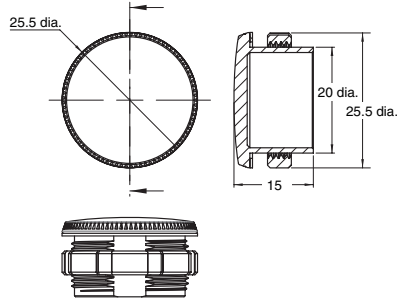
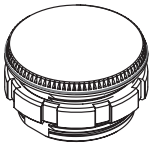

Lock Ring
A22NZ-A-403

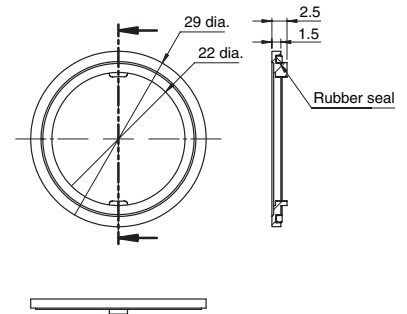
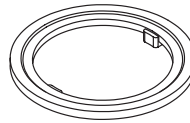

Control Box
A22NZ-A-B01Y

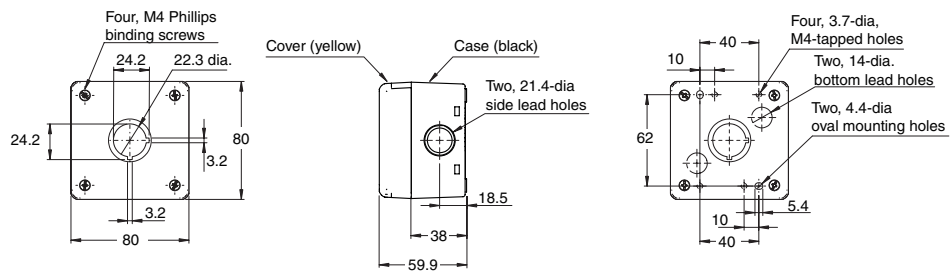
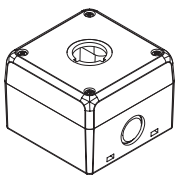

Lock Ring
A22NZ-A-50501

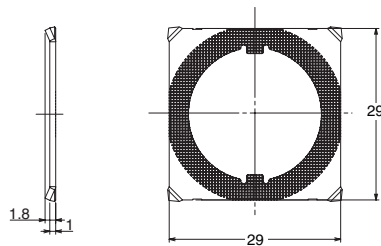

A22NN/A22NL

Dimensions

(Unit: mm)

Legend Plate Frames

Small A22NZ-A50103

Large A22NZ-A51103

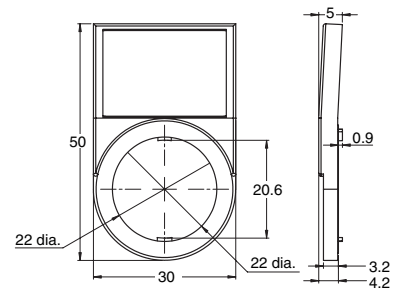
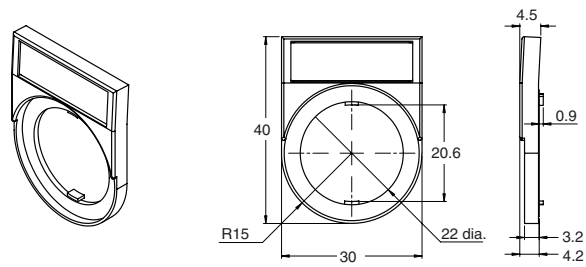

Legend Plates

Small A22Z-3443 □-□

Large A22Z-3453 □

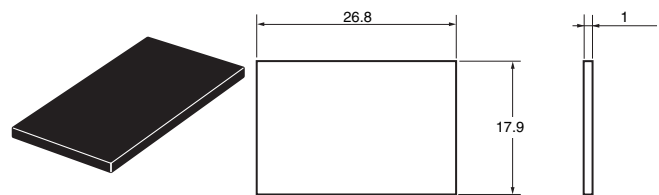
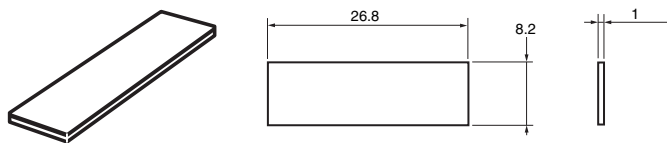

Cap Tightening Wrench

A22Z-3908

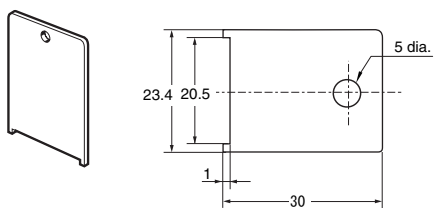

Safety Precautions

Refer to Safety Precautions for All Pushbutton Switches/Indicators.

Precautions for Safe Use

- Never perform wiring work on a Switch while power is being supplied. Never touch terminals and other charged parts while power is being supplied. Doing so may result in electrical shock.
- Never attempt to disassemble or modify the Switch in any way. Doing so may prevent correct operation.
- Switch functionality may be inhibited. Do not drop the Switch. Never apply a force that would deform or alter the nature of the Switch.
- The durability of the Switch is greatly affected by operating conditions. Evaluate the Switch under actual working conditions before permanent installation and use the Switch within a number of switching operations that will not adversely affect the Switch's performance.
- Do not use a load voltage or current that exceeds the rating. Doing so may damage or cause burning in the Switch.
- Do not use the Switch in a location with inflammable or explosive gases, or where the Switch would be subjected to inflammable solvents. The arcs and heat generated when the Switch is operated can cause ignition or explosions.
- Do not use the Switch where sulfur gas (H₂S, SO₂), ammonia gas (NH₃), nitric acid gas (HNO₃), chlorine gas (Cl₂), or other harmful gases are present or where high humidity is present. Contact faults and damage due to corrosion may interfere with the functionality of the Switch.
- Do not use the Switch in oil or water or in an environment subject to constant contact with oil or water. The oil or water may enter the Switch, causing failure.
- Do not use or store the Switch in the following locations.
 - Locations subject to rapid temperature changes
 - Locations subject to condensation due to high humidity
 - Locations subject to vibration
 - Locations subject to direct sunlight
 - Locations subject to salty air
- Make sure that the rubber washer is in place between the Operation Unit and the panel. Otherwise, the specifications of the protective structure may not be satisfied.
- Do not subject the Contact Block or wiring to excessive force. The Contact Block may be damaged or deformed and faulty contact may occur.

Precautions for Correct Use

Mounting

- Do not tighten the Mounting Nut more than necessary using tools such as pointed-nose pliers. Doing so will damage the Mounting Nut. (The tightening torque of the Mounting Nut is 1.0 to 2.0 N·m.)

Wiring

- Terminal screws must be M3.5 Phillips or slotted screws with a square washer.
- The terminal screw tightening torque is 1.0 to 1.3 N·m.
- Solid wires, stranded wires, and crimp terminals can be connected to the Switch.

Stranded wires: AWG14 to AWG16

Solid wire: 1.6 dia. max.

Bare Crimp Terminals

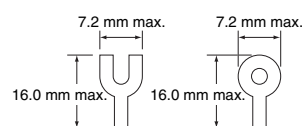

Crimp Terminals with Insulating Sheaths

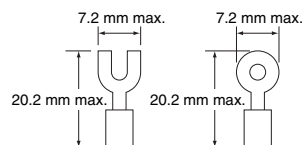

- After wiring the Switch, maintain appropriate clearance and creepage distances.

Operating Environment

- The Switch is intended for indoor use only. Using the Switch outdoors will result in failure.

LED Lamps

- A current-limiting resistor is built into the LED Lamp, so external resistance is not required.
- False Lighting of the LED Lamp
The LED Lamp will light with a microcurrent of approx. 0.1 mA or less. Take countermeasures, such as adding a resistor in parallel to the LED Lamp, to prevent false lighting.
The micro-current varies with the machine (due to leakage current, stray capacity between cables, etc.). Select a resistance value and allowable power consumption according to the actual current.

Example of Circuit to Prevent False Lighting

For 24 VAC/VDC Lighting Unit

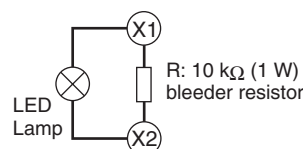

Application

Mounting to the Panel

Panel Hole Dimensions

- Panel hole dimensions are given below.
- The recommended panel thicknesses are given below.

Panel hole dimension	Panel thickness
22.3 dia.	0.8 to 5 mm
25.5 dia.	0.8 to 6 mm

- If outer surface treatment such as coating is performed for the panel, the panel dimensions after outer surface treatment must meet the specified panel dimensions.
- The following figure gives pitch dimension A and pitch dimension B between the centers of the mounting holes.

Panel Hole Dimensions for 22.3 Diameter

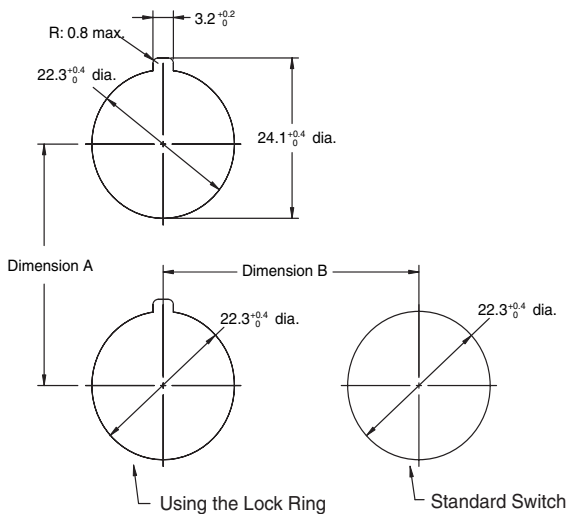

Panel Hole Dimensions for 25.5 Diameter

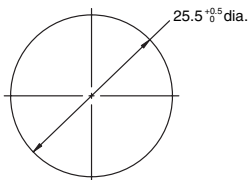

Dimension A

Wire type	Number of linked Contact Blocks	Number of wires per terminal	Minimum allowable pitch Dimension A (mm) or larger
Leads (twisted wires or solid wire)	1	1	50
Bare crimp terminals	1	1	50
Crimp terminals with insulating sheathes	1	1	60

Note: The minimum mounting pitch is based on three Contact Blocks in stage 1 with one wire attached to each terminal. If you attach two wires or link Units, determine the mounting pitch based on the dimensions diagrams and ease of operation and wiring.

Dimension A When Using Accessory

- Dimension A is 50 mm minimum when a Standard Legend Plate Frame is attached.
- Dimension A is 51 mm minimum when a Large Legend Plate Frame is attached.
- Dimension A is 75 mm minimum when a Protective Cover is attached.

Dimension B

Operation Unit shape	Dimension B
Mushroom	40 mm min.
Other than the above	30 mm min.

Mounting the Operation Unit

- **Panel Hole of 22.3-mm Diameter**
Insert the Operation Unit from the front of the panel, insert the Lock Ring and Mounting Nut from the back of the panel, and tighten the Mounting Nut. Before tightening, check that the rubber washer is present between the Operation Unit and the panel.

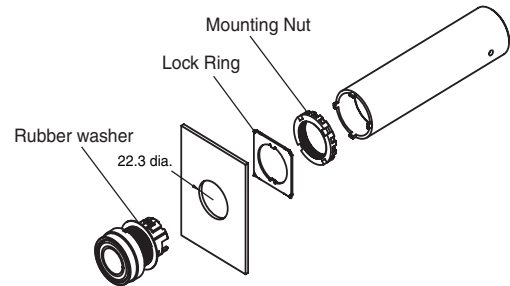

- **Panel Hole of 25.5-mm Diameter**
Do not use the Lock Ring, and tighten the Mounting Nut while confirming that the projecting part (see following figure) on the Mounting Nut is aligned with mounting hole. Before tightening, check that the rubber washer is present between the Operation Unit and the panel.

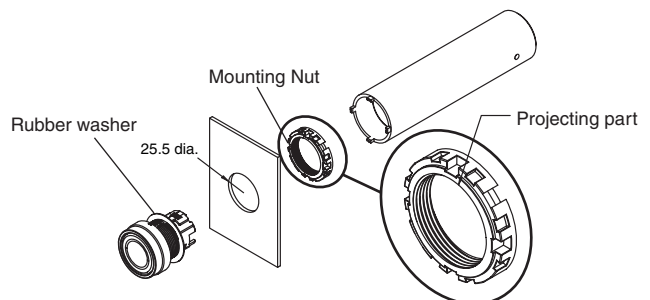

- Align the Lock Ring with the slot on the case and insert it so that the edge is flush with the panel.

Mounting the Contact Block to the Operation Unit

- Insert the Operation Unit into the Mounting Collar, aligning the TOP mark inscribed on the Operation Unit with the lever on the Mounting Collar, and then turn the lever in the direction indicated by the arrow in the following figure all of the way until it clicks into place.

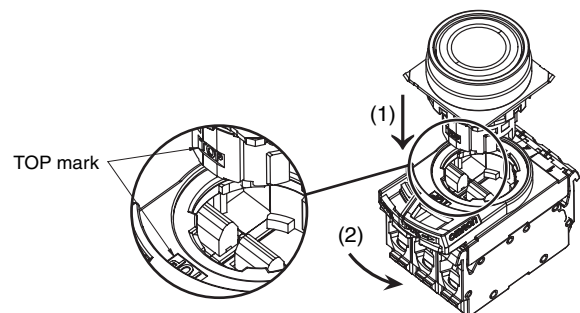

Removing the Mounting Collar

- Press the lock lever in from the back side to release the lock, and then hook the Mounting Collar with a screwdriver, move it in the direction indicated at (2), and remove it. Turn the lever all of the way until it clicks into place.

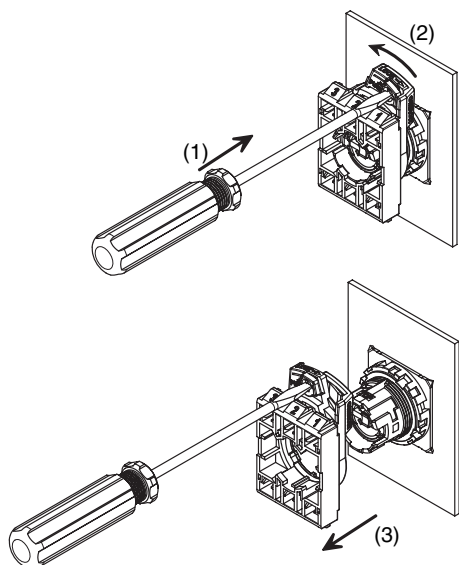

Contact Block

Attaching the Contact Block

- Catch the projection on the opposite side of the Mounting Collar from the lever side and press the Contact Block in the direction indicated at (1).

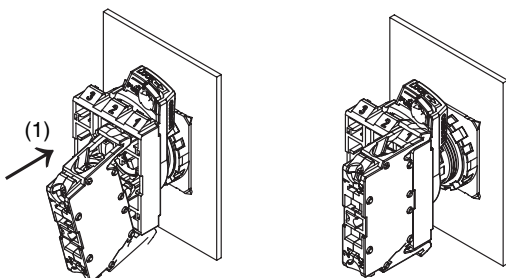

Removing the Contact Block

- Insert a screwdriver into the gap between the Mounting Collar and Contact Block and press it inward in the direction shown at (2).

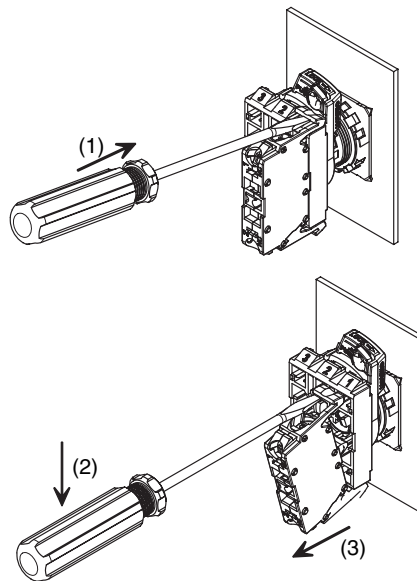

Attaching the Reinforcement Plate

- To link Contact Blocks together, attach a Reinforcement Plate in the direction shown in the following figure. To remove the Plate, insert a screwdriver in the direction indicated at (1) and rotate it in the direction indicated at (2).

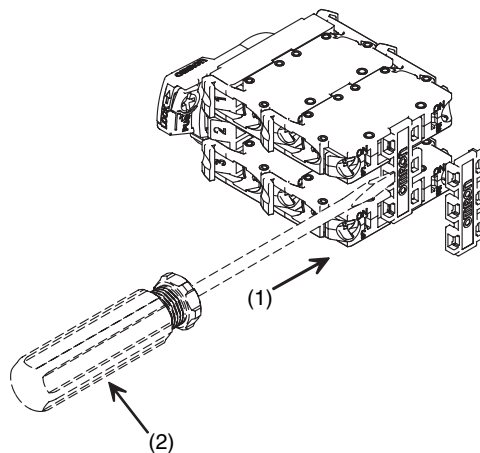

Engraving

- Engrave legends on the Legend Plates.
Do so with the straight part of the Legend Plate positioned on the right and left.
- The characters must be engraved no deeper than 0.5 mm. Use an alcohol-based paint, such as a melamine, phthalic acid, or acrylic resin based paint.

Projected, Full-guard, or Mushroom Switches	Flat Switches
<p>15.4 dia.</p>	<p>17.7 dia.</p>

Attaching Character Films

- To attach a character film, remove the Button and attach the film, aligning it with the straight portions of the Legend Plate.

Projected Switches

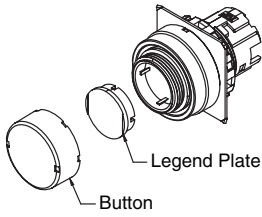

Full-guard Switches

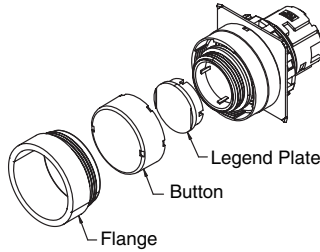

Mushroom Switches

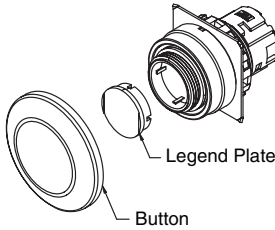

Flat Switches

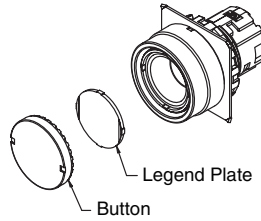

- Prepare films of the following sizes depending on the type of Legend Plate.

Projected, Full-guard, or Mushroom Switches	Legend Plate dimensions	
	Film dimensions	
Flat Switches	Legend Plate dimensions	
	Film dimensions	

Removing and Tightening the Cap

For all Switches except for Mushroom Switches, use the A22Z-3908 Cap Tightening Tool to loosen the cap. When you tighten the cap, make sure that the Legend Plate is in the correct position and then turn the cap in the direction opposite of the direction shown in the following figure. Tighten it to a torque of 0.5 to 1.0 N·m so that it will not become loose.

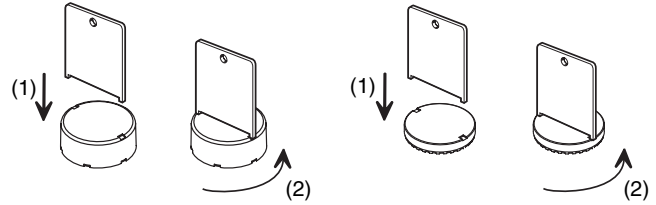

Attaching the LED Lamp to the Lighting Unit

- Insert the protrusions on the LED Lamp into the guides on the Lighting Unit and then turn the LED Lamp in direction (2) to lock it in place.

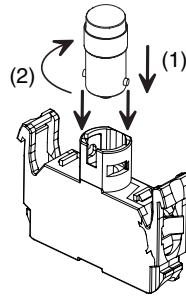

Attaching and Replacing LED Lamps

Removing the LED Lamp from the Panel Surface

- Insert the LED Lamp Extractor as shown in the following figure and then rotate the Extractor in the direction shown at (2) while pressing it inward.

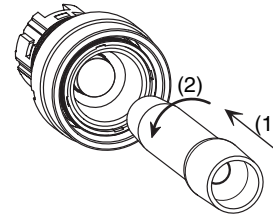

Attaching the LED Lamp from the Panel Surface

- Insert the LED Lamp into the LED Lamp Extractor as shown in the following figure. Align the projections on the LED Lamp with the LED Lamp insertion guides, insert the LED Lamp, and turn it in the direction indicated at (2).

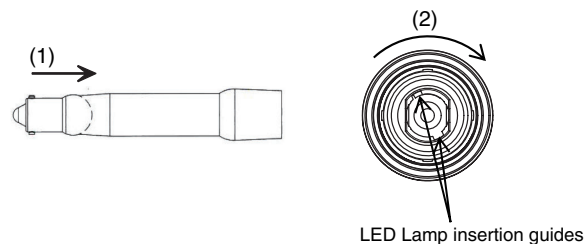

Control Box

You can attach a Legend Plate Frame.
 Attach it in the direction shown in the following figure.
 Mount the Switch in the same way as for a standard panel. The tightening torque of the Box screws is 1.4 to 2.0 N·m.

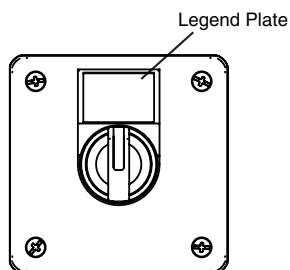

Creating a Cable Hole

To open a cable hole, leave the cover attached, place the tip of a screwdriver in the grooves at four locations around the cable hole, and strike the screwdriver with a hammer to open the hole.

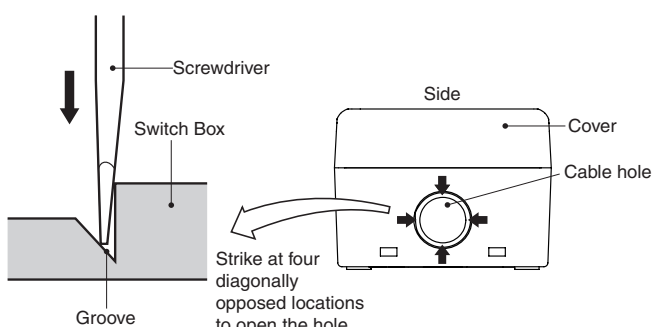

Attaching and Removing Legend Plates

- Press the Legend Plate into the depression in the Legend Plate Frame. The Legend Plate Frame can be separate or it can be mounted on the panel when you attach the Legend Plate.
- The direction of the characters will depend on the mounting direction of the Operation Unit if the Switch is a Selector Switch or Key Selector Switch.

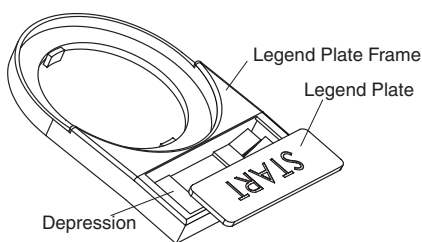

- You can easily remove the Legend Plate by pressing it forwards from the back of the Legend Plate Frame.
- The acrylic plastic Legend Plate is easily damaged by shock. Handle it with care.

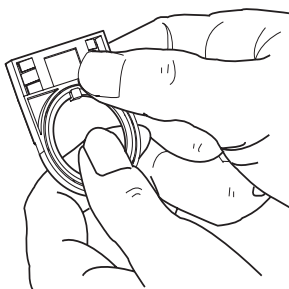

Attaching the Lock Ring

Attach the Lock Ring as shown in the following figure.
 To ensure water resistance, attach the rubber washer in the specified location.

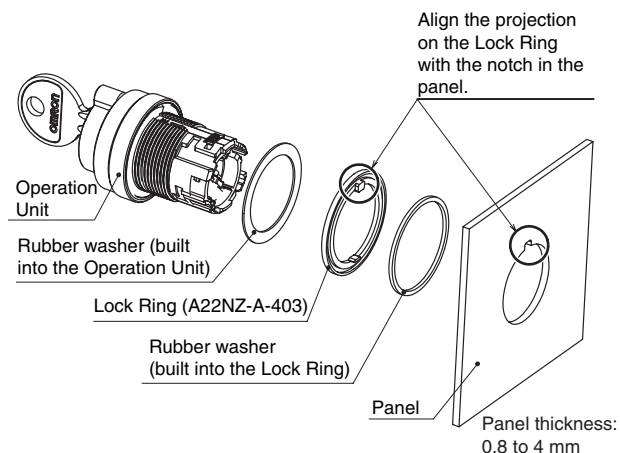

- Align the TOP mark on the Operation Unit, part A on the Legend Plate, and the notch in the panel, and insert the Operation Unit.

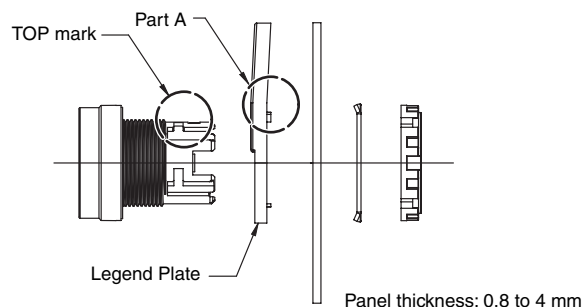

- If there is no notch in the panel, remove part A from the Legend Plate with pliers.

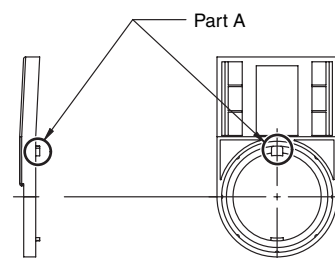

Attaching the Protective Cover

Attach the Protective Cover (A22NZ-A-303) to a panel that is 0.8 to 1.0 mm thick. To ensure water resistance, attach the rubber washer in the specified location.

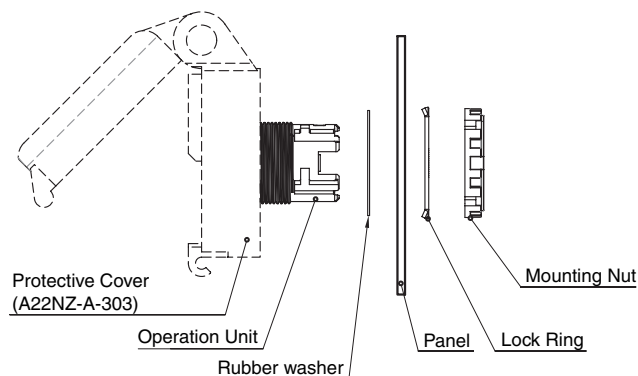

Terms and Conditions Agreement

Read and understand this catalog.

Please read and understand this catalog before purchasing the products. Please consult your OMRON representative if you have any questions or comments.

Warranties.

- (a) Exclusive Warranty. Omron's exclusive warranty is that the Products will be free from defects in materials and workmanship for a period of twelve months from the date of sale by Omron (or such other period expressed in writing by Omron). Omron disclaims all other warranties, express or implied.
- (b) Limitations. OMRON MAKES NO WARRANTY OR REPRESENTATION, EXPRESS OR IMPLIED, ABOUT NON-INFRINGEMENT, MERCHANTABILITY OR FITNESS FOR A PARTICULAR PURPOSE OF THE PRODUCTS. BUYER ACKNOWLEDGES THAT IT ALONE HAS DETERMINED THAT THE PRODUCTS WILL SUITABLY MEET THE REQUIREMENTS OF THEIR INTENDED USE.

Omron further disclaims all warranties and responsibility of any type for claims or expenses based on infringement by the Products or otherwise of any intellectual property right. (c) Buyer Remedy. Omron's sole obligation hereunder shall be, at Omron's election, to (i) replace (in the form originally shipped with Buyer responsible for labor charges for removal or replacement thereof) the non-complying Product, (ii) repair the non-complying Product, or (iii) repay or credit Buyer an amount equal to the purchase price of the non-complying Product; provided that in no event shall Omron be responsible for warranty, repair, indemnity or any other claims or expenses regarding the Products unless Omron's analysis confirms that the Products were properly handled, stored, installed and maintained and not subject to contamination, abuse, misuse or inappropriate modification. Return of any Products by Buyer must be approved in writing by Omron before shipment. Omron Companies shall not be liable for the suitability or unsuitability or the results from the use of Products in combination with any electrical or electronic components, circuits, system assemblies or any other materials or substances or environments. Any advice, recommendations or information given orally or in writing, are not to be construed as an amendment or addition to the above warranty.

See <http://www.omron.com/global/> or contact your Omron representative for published information.

Limitation on Liability; Etc.

OMRON COMPANIES SHALL NOT BE LIABLE FOR SPECIAL, INDIRECT, INCIDENTAL, OR CONSEQUENTIAL DAMAGES, LOSS OF PROFITS OR PRODUCTION OR COMMERCIAL LOSS IN ANY WAY CONNECTED WITH THE PRODUCTS, WHETHER SUCH CLAIM IS BASED IN CONTRACT, WARRANTY, NEGLIGENCE OR STRICT LIABILITY.

Further, in no event shall liability of Omron Companies exceed the individual price of the Product on which liability is asserted.

Suitability of Use.

Omron Companies shall not be responsible for conformity with any standards, codes or regulations which apply to the combination of the Product in the Buyer's application or use of the Product. At Buyer's request, Omron will provide applicable third party certification documents identifying ratings and limitations of use which apply to the Product. This information by itself is not sufficient for a complete determination of the suitability of the Product in combination with the end product, machine, system, or other application or use. Buyer shall be solely responsible for determining appropriateness of the particular Product with respect to Buyer's application, product or system. Buyer shall take application responsibility in all cases.

NEVER USE THE PRODUCT FOR AN APPLICATION INVOLVING SERIOUS RISK TO LIFE OR PROPERTY OR IN LARGE QUANTITIES WITHOUT ENSURING THAT THE SYSTEM AS A WHOLE HAS BEEN DESIGNED TO ADDRESS THE RISKS, AND THAT THE OMRON PRODUCT(S) IS PROPERLY RATED AND INSTALLED FOR THE INTENDED USE WITHIN THE OVERALL EQUIPMENT OR SYSTEM.

Programmable Products.

Omron Companies shall not be responsible for the user's programming of a programmable Product, or any consequence thereof.

Performance Data.

Data presented in Omron Company websites, catalogs and other materials is provided as a guide for the user in determining suitability and does not constitute a warranty. It may represent the result of Omron's test conditions, and the user must correlate it to actual application requirements. Actual performance is subject to the Omron's Warranty and Limitations of Liability.

Change in Specifications.

Product specifications and accessories may be changed at any time based on improvements and other reasons. It is our practice to change part numbers when published ratings or features are changed, or when significant construction changes are made. However, some specifications of the Product may be changed without any notice. When in doubt, special part numbers may be assigned to fix or establish key specifications for your application. Please consult with your Omron's representative at any time to confirm actual specifications of purchased Product.

Errors and Omissions.

Information presented by Omron Companies has been checked and is believed to be accurate; however, no responsibility is assumed for clerical, typographical or proofreading errors or omissions.

OMRON Corporation Industrial Automation Company

Tokyo, JAPAN

Contact: www.ia.omron.com

Regional Headquarters

OMRON EUROPE B.V.

Wegalaan 67-69, 2132 JD Hoofddorp
The Netherlands

Tel: (31)2356-81-300/Fax: (31)2356-81-388

OMRON ELECTRONICS LLC

2895 Greenspoint Parkway, Suite 200
Hoffman Estates, IL 60169 U.S.A

Tel: (1) 847-843-7900/Fax: (1) 847-843-7787

OMRON ASIA PACIFIC PTE. LTD.

No. 438A Alexandra Road # 05-05/08 (Lobby 2),
Alexandra Technopark,
Singapore 119967

Tel: (65) 6835-3011/Fax: (65) 6835-2711

OMRON (CHINA) CO., LTD.

Room 2211, Bank of China Tower,
200 Yin Cheng Zhong Road,
PuDong New Area, Shanghai, 200120, China

Tel: (86) 21-5037-2222/Fax: (86) 21-5037-2200

Authorized Distributor:

© OMRON Corporation 2015 All Rights Reserved.
In the interest of product improvement,
specifications are subject to change without notice.

Cat. No. A239-E1-01

0415 (0415)